



**LEARN MORE WITH
OUR HOW-TO VIDEOS**

www.youtube.com/FroniusSolar

Fronius Energy Package

Operating Instructions

EN

Grid-connected inverter



Dear reader,

Introduction

Thank you for the trust you have placed in our company and congratulations on buying this high-quality Fronius product. These instructions will help you familiarise yourself with the product. Reading the instructions carefully will enable you to learn about the many different features it has to offer. This will allow you to make full use of its advantages.

Please also note the safety rules to ensure greater safety when using the product. Careful handling of the product will repay you with years of safe and reliable operation. These are essential prerequisites for excellent results.

Explanation of safety symbols



DANGER! Indicates immediate and real danger. If it is not avoided, death or serious injury will result.



WARNING! Indicates a potentially dangerous situation. Death or serious injury may result if appropriate precautions are not taken.



CAUTION! Indicates a situation where damage or injury could occur. If it is not avoided, minor injury and/or damage to property may result.



NOTE! Indicates a risk of flawed results and possible damage to the equipment.

IMPORTANT! Indicates tips for correct operation and other particularly useful information. It does not indicate a potentially damaging or dangerous situation.

If you see any of the symbols depicted in the "Safety rules" chapter, special care is required.

Contents

Safety rules	9
General	9
Environmental conditions	9
Qualified service engineers	10
Noise emission values	10
EMC measures	10
Emergency power	10
Disposal	11
Copyright	11
Data protection	11
General information	13
Fronius Symo Hybrid	15
Device concept	15
Proper use	16
Warning notices on the device	16
Product registration	17
Fronius Solar Battery	18
Device concept	18
Proper use	18
Increase in storage capacity	19
Warning notices on the device	19
The various operating modes	21
Operating modes – Explanation of symbols	21
Operating mode: Inverter	21
Operating mode: Inverter plus battery	22
Operating mode: Inverter plus battery and emergency power function	22
Operating statuses (only for systems with a battery)	23
Emergency power mode	25
Prerequisites for emergency power mode	25
Transition from grid-connected operation to emergency power mode	25
Transition from emergency power mode to grid-connected operation	25
Restrictions in emergency power mode	25
Emergency power and energy saving mode	26
Energy saving mode	27
General remarks	27
Fronius Solar Battery and Fronius Symo Hybrid switch-off conditions	27
Fronius Symo Hybrid and Fronius Solar Battery switch-on conditions	27
Special case	28
Indicators on the displays and user interfaces	28
Calibration charging	29
General remarks	29
Benefits of calibration charging	29
Conditions for the start of calibration charging	29
Calibration charging procedure	29
Calibration process	29
Duration of calibration charging	30
Limitations during calibration	30
Display during calibration charging	30
Operation	33
Data communication	35
Data communication area	35
General	35
Controls, connections and indicators on the system monitoring unit	36
Fronius Hybrid inverter	39
Controls and indicators	39
Display	40

Fronius Solar Battery	41
Battery management module	41
Battery module	41
Display	41
Display types.....	42
Data converter connections	45
Data converter controls and indicators	45
Data converter LED displays	45
Navigation at the menu level.....	47
Activate display backlighting	47
Automatic deactivation of display backlighting / choose 'NOW' menu item	47
Open menu level.....	47
Values displayed under the NOW menu item	47
Values displayed under the LOG menu item	48
Menu items in the Set-up menu	49
Standby.....	49
Relays	49
Energy Manager(under Relay menu item).....	50
Time / Date	51
Display settings.....	51
Energy yield	52
Fan.....	53
SETUP menu item	54
Initial setting	54
Software updates	54
Navigating the SETUP menu item	54
Setting entries on the Setup menu, general.....	55
Application example: Setting the time.....	55
The INFO menu item	57
Measured values.....	57
PSS status	57
Grid status.....	57
Device information	57
Version.....	58
Switching the key lock on and off.....	60
General	60
Switching the key lock on and off.....	60
The Basic menu	61
Access the Basic menu.....	61
Items on the Basic menu	61

Fronius system monitoring 63

General	65
General remarks	65
Prerequisites for operation.....	65
Calculating data volumes	66
General	66
Calculating data volumes.....	66
General information for the network administrator	68
Prerequisites	68
General firewall settings.....	68
Using Fronius Solar.web and sending service messages	69
Installing Fronius system monitoring – Overview.....	70
Safety.....	70
Using for the first time	70
Information to help you work through the Solar Web wizard	72
Testing emergency power mode.....	72
Connecting to Fronius system monitoring via a web browser.....	73
General remarks	73
Prerequisites	73
Establishing a connection to Fronius system monitoring via a web browser	73
Connecting to Fronius system monitoring established via the Internet and Fronius Solar.web.....	74
General remarks	74

Functional description	74
Prerequisites	74
Accessing Fronius system monitoring data via the Internet and Fronius Solar.web.....	74

Current data, services and settings offered by Fronius system monitoring 75

The Fronius system monitoring web page	77
Fronius system monitoring web page – Overview	77
The Settings menu.....	77
Additional setting options	78
Services – System information	79
System information	79
Services – Network diagnostics	81
Network diagnostics.....	81
Services – Firmware update	82
General	82
Searching for updates automatically.....	82
Searching for updates manually	83
Updating the firmware via the Web.....	83
Updating the firmware via a LAN	83
Services – Starting the wizard	85
Starting the wizard	85
Settings – General	86
General	86
Settings – Passwords	87
General remarks	87
Passwords	87
Settings – Network.....	89
General	89
Network.....	89
Settings – Fronius Solar.web	93
Fronius Solar.web	93
Settings – Service messages.....	95
General remarks	95
Service messages.....	95
Settings – IO mapping	97
General.....	97
Emergency power.....	97
Load management.....	97
IO control	97
AUS - Demand Response Modes (DRM)	98
Settings - load management	100
Load management.....	100
Settings – Push Service.....	101
Push Service.....	101
Further information about the push service function.....	102
Settings – Modbus	103
General remarks	103
Further information about the Modbus function	103
Exporting data via Modbus	103
Restricting control	104
Saving or discarding changes.....	105
Settings – Energy Manager	106
General	106
Energy Manager examples	106
Battery management.....	108
Example of reserve battery capacity.....	109
Settings – System overview	110
System overview.....	110
Fronius Smart Meter	111
Settings – EVU Editor	113
General remarks	113
PSC Editor – IO control.....	113
Connection example	114

"PSC editor - AUS - Demand Response Modes (DRM)"	115
EVU Editor – Dynamic power reduction.....	115
EVU Editor – Control priorities	117
EVU Editor – Batterie Ladung [Battery charging].....	117
Dynamic power regulation with several inverters.....	118
Settings – Battery.....	120
Battery.....	120

Troubleshooting and maintenance **121**

Fronius Symo Hybrid	123
Displaying status codes	123
Total failure of the display	123
Status codes – Class 1	123
Status codes – Class 3	124
Status codes – Class 4	125
Status codes – Class 5	126
Status codes – Class 6	128
Status codes – Class 7	128
Status codes – Class 9	129
Class 10 - 12 status codes.....	130
Customer service	130
Operation in dusty environments	130
Fronius Solar Battery	131
Status code display.....	131
Error messages – Battery management module	131
Error message – Data converter.....	131
Undefined operating statuses	132

Appendix **133**

Technical data.....	135
System monitoring	137
Explanation of footnotes	137
Applicable standards and guidelines	138
Warranty terms and conditions, and disposal	139
Fronius manufacturer's warranty	139
Disposal	139

Safety rules

General



The device is manufactured using state-of-the-art technology and according to recognised safety standards. If used incorrectly or misused, however, it can cause:

- injury or death to the operator or a third party,
- damage to the device and other material assets belonging to the operator,
- inefficient operation of the device.

All persons involved in commissioning, maintaining and servicing the device must

- be suitably qualified,
- have knowledge of and experience in dealing with electrical installations and
- read and follow these operating instructions carefully.

The operating instructions must always be at hand wherever the device is being used. In addition to the operating instructions, attention must also be paid to any generally applicable and local regulations regarding accident prevention and environmental protection.

All safety and danger notices on the device

- must be in a legible state,
- must not be damaged,
- must not be removed,
- must not be covered, pasted or painted over.

The terminals can reach high temperatures.



Only operate the device when all protection devices are fully functional. If the protection devices are not fully functional, there is a risk of

- injury or death to the operator or a third party,
- damage to the device and other material assets belonging to the operator,
- inefficient operation of the device.

Any safety devices that are not functioning properly must be repaired by a suitably qualified engineer before the device is switched on.

Never bypass or disable protection devices.

For the location of the safety and danger notices on the device, refer to the "General" section in the operating instructions for the device.

Before switching on the device, rectify any faults that could compromise safety.

This is for your personal safety!

Environmental conditions



Operation or storage of the device outside the stipulated area will be deemed as "not in accordance with the intended purpose". The manufacturer shall not be held liable for any damage arising from such usage.

For exact information on permitted environmental conditions, please refer to the "Technical data" in the operating instructions.

Qualified service engineers



The servicing information contained in these Operating Instructions is intended only for the use of qualified service engineers. An electric shock can be fatal. Do not perform any actions other than those described in the documentation. This applies even if you are qualified to do so.



All cables and leads must be secured, undamaged, insulated and adequately dimensioned. Loose connections, scorched, damaged or inadequately dimensioned cables and leads must be immediately repaired by authorised personnel.



Maintenance and repair work must only be carried out by authorised personnel.

It is impossible to guarantee that bought-in parts are designed and manufactured to meet the demands made of them, or that they satisfy safety requirements. Use only original spare parts (also applies to standard parts).

Do not carry out any modifications, alterations, etc. to the device without the manufacturer's consent.

Components that are not in perfect condition must be replaced immediately.

Noise emission values



The maximum sound power level of the inverter is specified in the Technical Data.

The device is cooled as quietly as possible with the aid of an electronic temperature control system; this depends on the amount of converted power, the ambient temperature, the level of soiling of the device, etc.

It is not possible to provide a workplace-related emission value for this device because the actual sound pressure level is heavily influenced by the installation situation, the power quality, the surrounding walls and the properties of the room in general.

EMC measures



In certain cases, even though a device complies with the standard limit values for emissions, it may affect the application area for which it was designed (e.g. when there is sensitive equipment at the same location, or if the site where the device is installed is close to either radio or television receivers). If this is the case, then the operator is obliged to take appropriate action to rectify the situation.

Emergency power

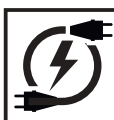

This system is equipped with an emergency power function. This means a backup power supply is automatically established in the event of a power outage.

For maintenance and installation work, the system must both be isolated from the grid, and backup power mode must be disabled by opening the integrated DC disconnect on the inverter.

The emergency power supply is automatically activated and deactivated depending on the insolation conditions and the state of charge of the battery. This means that emergency power can be re-established unexpectedly when in standby mode. For this reason, when the emergency power supply is deactivated, switch off all connected devices and do not undertake any installation work on the household network.

Disposal



To comply with the European Directive 2002/96/EC on Waste Electrical and Electronic Equipment and its implementation as national law, electrical equipment that has reached the end of its life and dead batteries must be sorted from general waste and returned to an approved recycling facility. Any device that you no longer require must either be returned to your dealer or given to one of the approved collection and recycling facilities in your area. Ignoring this European Directive may be harmful to the environment and your own health!

If you need to replace your battery at some point, Fronius will take back the old device and arrange for it to be recycled in an appropriate manner.

Copyright



Copyright of these operating instructions remains with the manufacturer.

The text and illustrations are all technically correct at the time of printing. We reserve the right to make changes. The contents of the operating instructions shall not provide the basis for any claims whatsoever on the part of the purchaser. If you have any suggestions for improvement, or can point out any mistakes that you have found in the instructions, we will be most grateful for your comments.

Data protection



The user is responsible for the safekeeping of any changes made to the factory settings. The manufacturer accepts no liability for any deleted personal settings.

General information

Fronius Symo Hybrid

Device concept

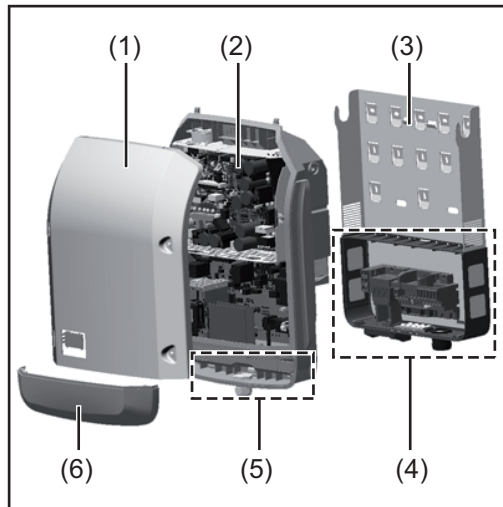

Device design:

- (1) Housing lid
- (2) Inverter
- (3) Wall bracket
- (4) Connection area including DC main switch
- (5) Data communication area
- (6) Data communication cover

The hybrid inverter converts the direct current generated by the solar modules into alternating current. This alternating current is fed into the public grid synchronously with the grid voltage. In addition, the solar energy can be stored in a connected Fronius Solar Battery for later use.

The hybrid inverter has been developed specifically for use in grid-connected photovoltaic systems. Emergency power mode is possible provided that appropriate wiring has been installed.

Thanks to its design and operating principle, the inverter is extremely safe both to install and to operate.

The inverter monitors the public grid automatically. In the event of abnormal grid conditions, the inverter ceases operating immediately and stops feeding power into the grid (e.g. if the grid is switched off, if there is an interruption, etc.).

Grid monitoring involves voltage, frequency and islanding detection monitoring. The inverter switches to emergency power mode provided that appropriate wiring has been installed.

Operation of the inverter is fully automatic.

The inverter is designed to draw as much power from the solar modules as possible.

Depending on the operating point, this power is either stored in the battery, fed into the grid or used for the household network in emergency power mode.

As soon as the solar modules stop providing sufficient energy, the power from the Fronius Solar Battery is fed into the household network. Depending on the selected setting, power can also be drawn from the public grid for the purpose of charging the battery.

If the inverter becomes too hot, it automatically reduces the current output power or charging power, or switches to emergency power mode in order to protect itself.

Reasons for the inverter becoming too hot include the ambient temperature being too high or inadequate heat dissipation (e.g. if it is installed in a switch cabinet without suitable heat dissipation).

IMPORTANT! The Fronius Solar Battery is only to be switched on when the inverter is in Standby mode.

Proper use

The solar inverter is exclusively intended for charging a Fronius Solar Battery with direct current from solar modules, or for converting this direct current into alternating current and feeding it into the public grid or the household network in emergency power mode.

The following actions constitute improper use:

- Any use above and beyond this purpose
- Making any modifications to the inverter that have not been expressly approved by Fronius
- Installing components that are not distributed or expressly approved by Fronius
- Operating the device with a battery that has not been approved by Fronius
- Operating the equipment with an energy meter that has not been approved by Fronius

Fronius shall not be liable for any damage resulting from such action.

No warranty claims will be entertained.

Proper use also includes:

- Carefully studying and obeying the installation and operating instructions
- performing all stipulated inspection and maintenance work

When designing the photovoltaic system, ensure that all of its components are operated within their permitted operating ranges at all times.

Observe all the measures recommended by the solar module manufacturer to ensure that the solar module retains its properties in the long term.

Observe the stipulations of the power supply company concerning energy fed into the grid, emergency power mode and the operation of storage systems.

The Fronius Symo Hybrid is a grid-connected inverter with an emergency power function – it is not a stand-alone inverter. The following restrictions must therefore be observed in emergency power mode:

- Emergency power mode may amount to max. 15% of the normal inverter operating time
- Emergency power mode must be in operation for (at least) 1500 hours

Warning notices on the device

There are warning notices and safety symbols on and in the inverter. These warning notices and safety symbols must not be removed or painted over. They warn against incorrect operation, as this may result in serious injury and damage.



Safety symbols:



Risk of serious injury and damage due to incorrect operation



Do not use the functions described here until you have fully read and understood the following documents:

- these operating instructions
- All the operating instructions for the system components of the photovoltaic system, especially the safety rules



Dangerous electrical voltage



Wait for the capacitors to discharge.

Text of the warning notices:

WARNING!

An electric shock can be fatal. Make sure that both the input side and output side of the device are de-energised before opening the device. Wait for the capacitors to discharge (6 minutes).

Product registration

Why do I need to register?

By registering easily and for free, you will benefit from additional years of warranty. You only need to fill out a few details and confirm the registration.

Who can register a device?

The warranty agreement is concluded between Fronius and the warranty holder (owner of the installed system). For this reason, the system must be registered by the warranty holder using their Solar.web login credentials. Registration may only be performed by third parties if they have been authorised to do so. Non-compliance may result in a penalty. The warranty will be invalid if incorrect details are provided.

How can I register?

Log in to the website www.solarweb.com and click on the "PRODUCT REGISTRATION" field. More information can be found at in the product registration area.

Where can I find the serial number for my product?

The serial number can be found on the rating plate of the inverter and the Solar Battery. For the Solar Battery, only use the serial number shown in the picture. The serial numbers of the individual battery modules are not relevant.

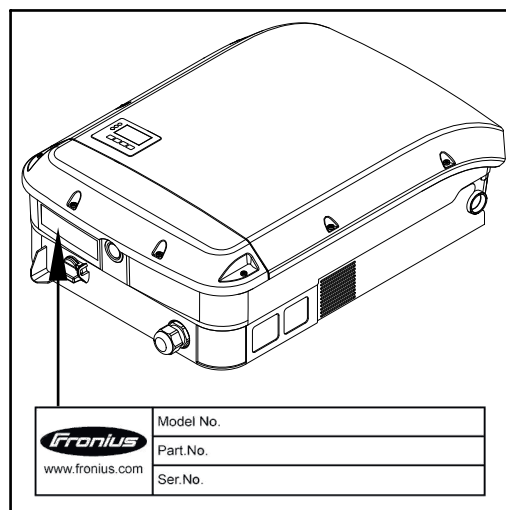
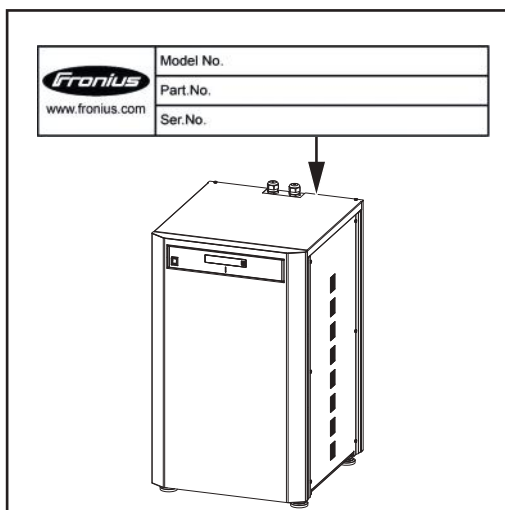

Fronius Solar Battery

Device concept

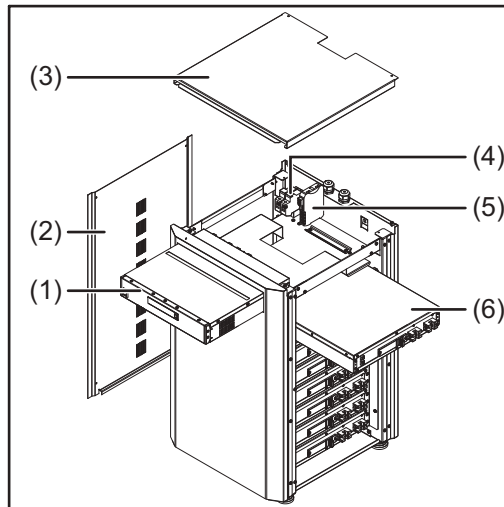

Device design:

- (1) Battery management module
- (2) Side panel
- (3) Lid
- (4) Fuses
- (5) Data converter
- (6) Battery module (1.2 kWh usable capacity)

With the market launch of its new Fronius Energy Package, Fronius is introducing an inverter that can be used to store energy. One of the key components is the Fronius Solar Battery, which contains a lithium-ion rechargeable cell. The Fronius Solar Battery supplements the Fronius hybrid inverter by adding storage functionality. This means that the solar energy from the solar modules can be stored for later use.

The storage system is only suitable for operation in conjunction with Fronius hybrid inverters.

Thanks to its design and operating principle, the storage system is extremely safe both to install and to operate. A high-performance lithium-ion phosphate battery is used (LiFePO₄), which is based on the latest technology and complies with the highest safety standards.

When used in conjunction with the Fronius inverter, operation of the storage system is fully automatic.

If proper charging of the batteries in the Fronius Energy Package cannot be guaranteed for an extended period of time (over several weeks or months) for any reason, we strongly recommend that the following steps are undertaken to prevent the deep discharge of the battery modules:

- switch off the main switch of the Fronius Solar Battery
- remove the DC fuses from the fuse holder
- remove the orange power connector from the individual battery modules

Proper use

The Fronius Solar Battery is exclusively intended for taking direct current from a Fronius hybrid inverter and storing it for later use.

The following actions constitute improper use:

- Any use above and beyond this purpose
- Making any modifications to the storage system that have not been expressly approved by Fronius
- Installing components that are not distributed or expressly approved by Fronius
- Operating the system with an inverter that has not been approved by Fronius
- Operating the equipment with an energy meter that has not been approved by Fronius

Fronius shall not be liable for any damage resulting from such action.
No warranty claims will be entertained.

Proper use also includes:

- Carefully studying and obeying the installation and operating instructions
- performing all stipulated inspection and maintenance work

Observe the stipulations of the power supply company concerning energy fed into the grid and the operation of storage systems.

Increase in storage capacity

The storage capacity of the Fronius Solar Battery can be increased to the maximum capacity of 9.6 kWh of useable energy even after purchase by adding additional battery modules.

This work must be carried out by an electrician.







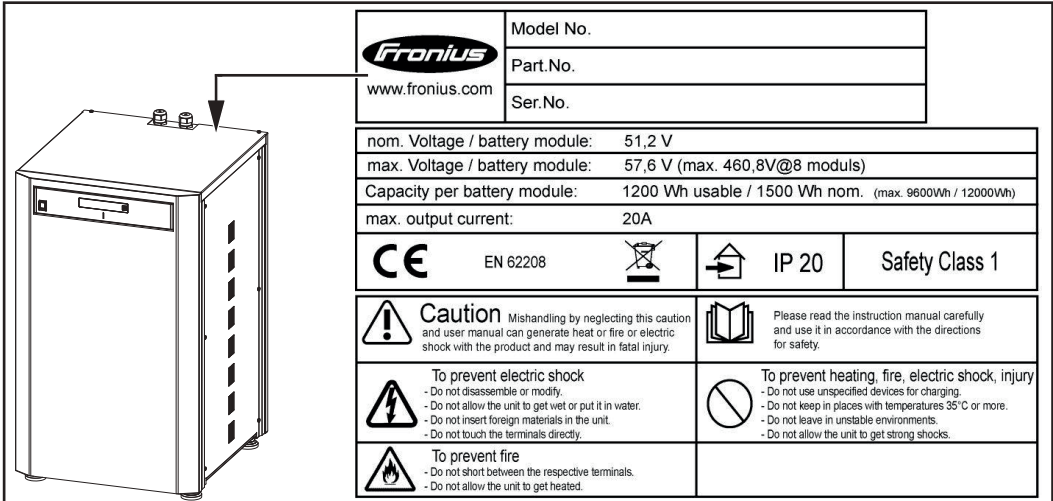

The capacity can be increased at Fronius Austria up to two years after the purchase date and a maximum of 30 months after dispatch.

Capacity increases after this time are not possible for technical reasons. Observe the stipulations of the power supply company concerning energy fed into the grid and the operation of storage systems.

Warning notices on the device

Warning notices and safety symbols are affixed to the battery. These warning notices and safety symbols must not be removed or painted over. They warn against incorrect operation, as this may result in serious injury and damage.



	Model No.	
	Part.No.	
	www.fronius.com	
	Ser.No.	
nom. Voltage / battery module: 51,2 V		
max. Voltage / battery module: 57,6 V (max. 460,8V@8 moduls)		
Capacity per battery module: 1200 Wh usable / 1500 Wh nom. (max. 9600Wh / 12000Wh)		
max. output current: 20A		
	EN 62208	 IP 20
		Safety Class 1
	Caution Mishandling by neglecting this caution and user manual can generate heat or fire or electric shock with the product and may result in fatal injury.	 Please read the instruction manual carefully and use it in accordance with the directions for safety.
	To prevent electric shock - Do not disassemble or modify. - Do not allow the unit to get wet or put it in water. - Do not insert foreign materials in the unit. - Do not touch the terminals directly.	 To prevent heating, fire, electric shock, injury - Do not use unspecified devices for charging. - Do not keep in places with temperatures 35°C or more. - Do not leave in unstable environments. - Do not allow the unit to get strong shocks.
	To prevent fire - Do not short between the respective terminals. - Do not allow the unit to get heated.	

Safety symbols – Text of the warning notices:

 **CAUTION!** Incorrect handling or failing to observe these notices and the operating instructions is extremely dangerous. It may give rise to thermal/electrical or fire hazards, thereby resulting in serious injuries.

 Please read the operating instructions carefully while also ensuring compliance with the safety instructions during use!

 **To avoid electric shocks:**

- Do not dismantle or modify the device
- Do not allow any water to enter the device
- Do not allow any foreign substances or material to enter the device
- Do not touch any connections directly



To avoid overheating, the risk of fire, electric shocks or injuries:

- Do not use any unspecified charging devices
- Do not use in room temperatures of 35 °C or above
- Do not use in unstable environments
- Do not expose to any strong vibrations



To avoid the risk of fire:

- Do not short-circuit individual connections
- Avoid overheating

What to do in an emergency:

a) Fire:

- Suitable extinguishing agents: CO₂ or powder extinguisher; fire extinguishing equipment that involves the use of water can result in electric shocks.
- Notify fire brigade
- Notify anyone who is in danger
- Switch off main switch
- Open residual current-operated circuit breaker

b) Flooding:

- Switch off main switch
- Open residual current-operated circuit breaker
- Protect system from water, pump water away

c) Undefined operating status (see also section titled "Undefined operating statuses" on page 132):

- Ensure adequate ventilation.
- Switch off main switch
- Open residual current-operated circuit breaker

The various operating modes

Operating modes – Explanation of symbols

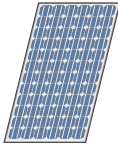

Solar module
Generates direct current



Inverter – Fronius hybrid
Converts the direct current into alternating current and charges the battery. Thanks to the built-in system monitoring function, the inverter can be integrated into a network using WLAN technology.



Battery – Fronius Solar Battery
Connected to the inverter on the DC side and used to store electrical energy

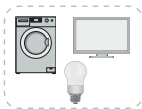

Photovoltaic system consumers
The consumers connected to the PV system (single or three-phase)



Meter – Fronius Smart Meter
For optimum energy management. You can have the meter installed in a switch cabinet by your electrical installer.



Emergency power function
The inverter is delivered ready for supplying emergency power. However, the electrical installer must set up the emergency power function in the switch cabinet. In emergency power mode, the PV system operates as a stand-alone island.



Grid

Operating mode: Inverter

The Fronius hybrid inverter can be used purely as an inverter without a battery connected to it.

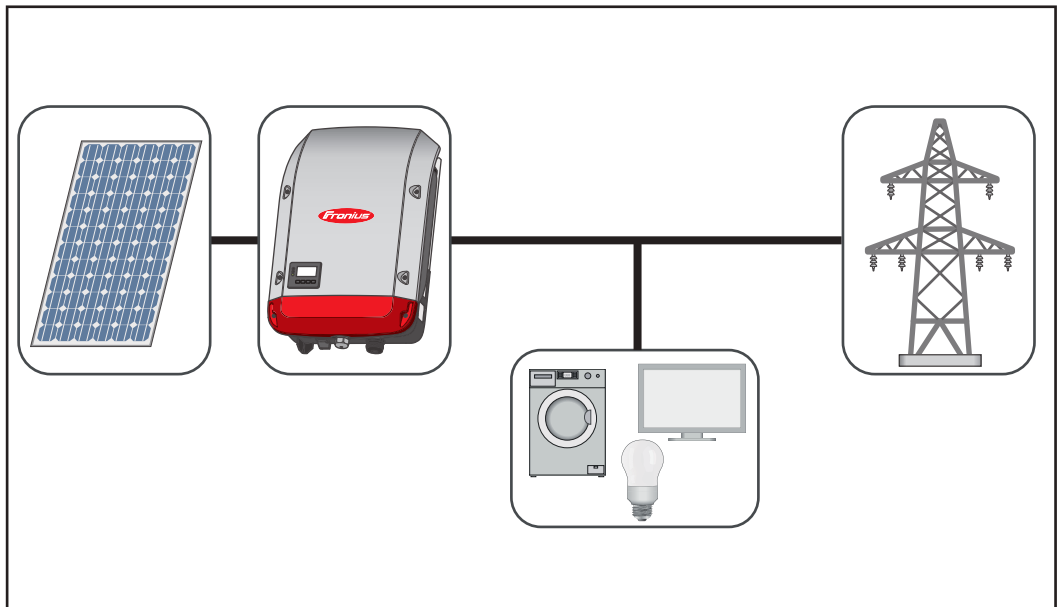

**Operating mode:
Inverter plus bat-
tery**

To ensure fault-free regulation, parallel operation of several Fronius Energy Packages is not permitted.

To maximise self-consumption of the energy provided by your PV system, you can use a Fronius Solar Battery to act as a storage system. The Fronius Solar Battery is connected to the inverter on the DC side. As a result, there is no need for multiple current conversion processes, leading to greater efficiency.

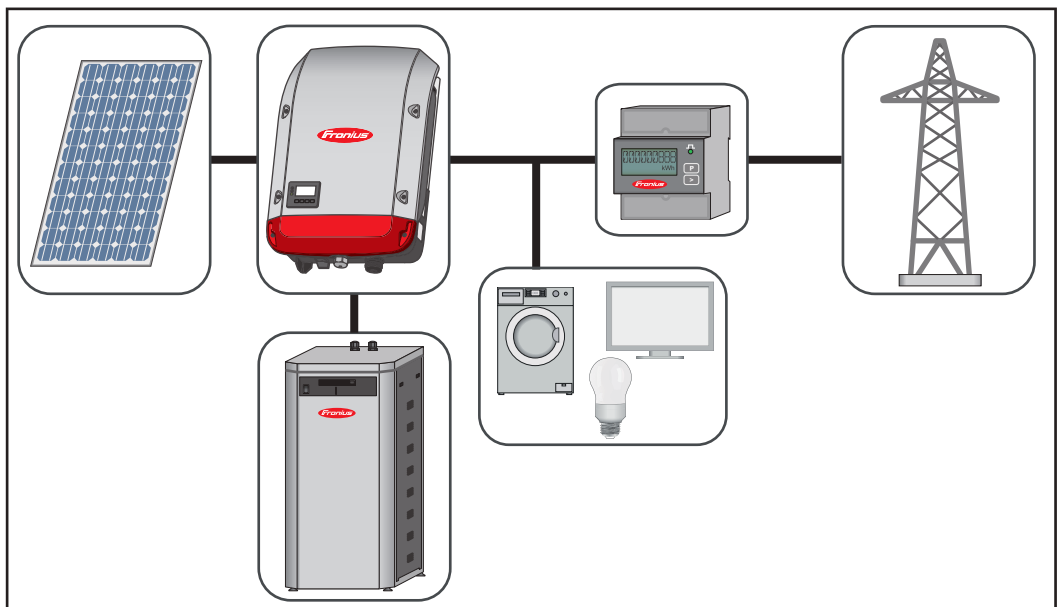

**Operating mode:
Inverter plus bat-
tery and emer-
gency power
function**

IMPORTANT! In emergency power mode, an increased nominal frequency is used in order to avoid parallel operation with other generators.

To ensure fault-free regulation, parallel operation of several Fronius Energy Packages is not permitted.

When the hybrid PV system is equipped with all the available features, the inverter can:

- Feed energy into the grid
- Supply the devices that are connected to the PV system with power in the event of a power failure
- Use any excess energy to charge the Fronius Solar Battery

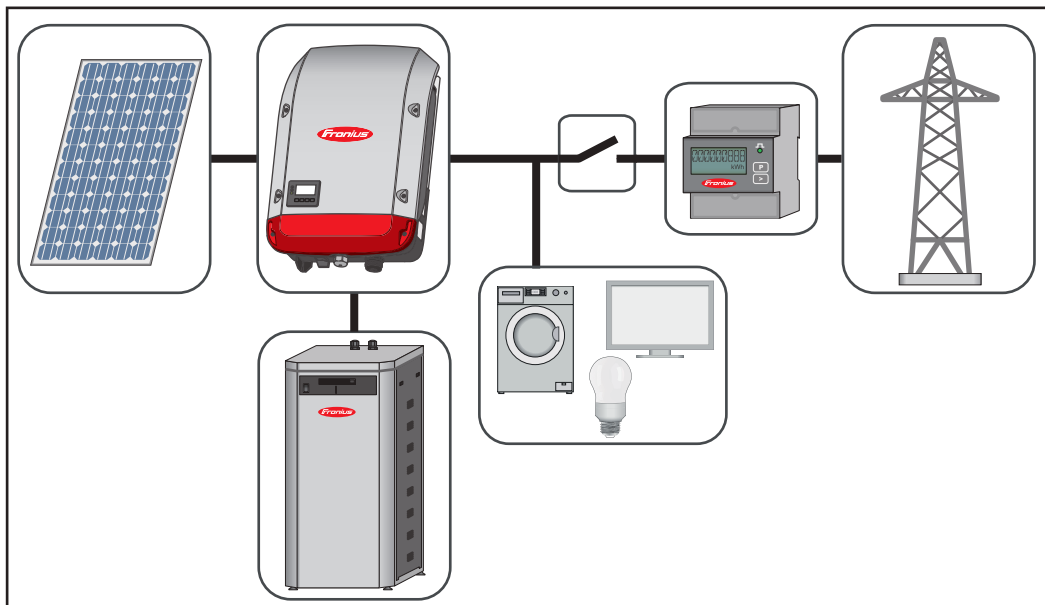

Operating statuses (only for systems with a battery)

The Fronius Energy Package differentiates between various operating statuses. The current operating status is displayed on the system monitoring website or in Fronius Solar.web.

Operating status	Description
Deactivated	The battery is not active. It has either been deactivated, or no communication with the battery or meter is possible due to a fault.
Normal operation	The system is in normal operation
Service mode	Service mode has been activated. The battery is automatically charged or discharged to a defined SOC value and then kept at this value until service mode is ended manually.
Forced re-charging	The Fronius Symo Hybrid recharges the battery to counteract self discharge and maintain the set minimum SOC (protection against deep discharge).
Min. SOC reached	The battery has reached the set minimum SOC. The battery cannot be discharged further until it has been charged again.
Energy saving mode	The system has been set to energy-saving mode. All LEDs and the battery display do not light up. The inverter display also does not light up. Energy-saving mode ends automatically when sufficient excess energy is available.
Calibration mode	The system is in calibration mode. When there is insufficient PV energy available to reach 100%, the battery is cyclically charged to 100% for internal calibration. Under certain conditions (depending on weather, microcycles, temperature, etc.), this can take an extended period of time (up to several days).

Operating status	Description
Deep discharge protection	Battery not found. No communication is possible with the battery and the battery voltage is not present at the inverter.
Start	The inverter is starting from energy saving mode (Stand-by), while the battery is already active.

Emergency power mode

Prerequisites for emergency power mode

In order to use the hybrid inverter's emergency power function, the following prerequisites must be fulfilled:

- Correct cabling of the emergency power system in the electrical installation (see document entitled "Fronius Energy Package - Examples of emergency power switch-over")
- The meter (Fronius Smart Meter) must be installed at the feed-in point and configured
- Latest firmware on the inverter - if required, perform a firmware update
- Select Alternative (emergency power) setup in the CONFIG menu on the inverter (see installation instructions)
- Change the required settings in the emergency power area in the IO mapping menu (Fronius system monitoring web page → Settings → IO mapping → Emergency power)
- Set the system to "Auto" in the emergency power system overview (Fronius system monitoring web page → Settings → System overview → Emergency power operating mode)

Transition from grid-connected operation to emergency power mode

1. The public grid is monitored by the inverter's internal grid and system protection and by the Fronius Smart Meter connected to it.
2. **The public grid fails or specific grid parameters are not reached or exceeded.**
3. The inverter carries out the measures necessary according to the country standard and then switches off.
4. The inverter starts emergency power mode after a checking period.
5. All consumers in the household that are in the emergency power circuit are supplied by the Fronius Solar Battery and the solar modules. The remaining consumers are not supplied with power and are safely isolated.

Transition from emergency power mode to grid-connected operation

1. The inverter is operating in emergency power mode.
2. **The public grid is functioning correctly again.**
3. The Fronius Smart Meter monitors the grid parameters on the public grid and passes this information to the inverter.
4. After a defined measuring period, the restored public grid is deemed to be stable.
5. The inverter ends emergency power mode.
6. All circuits are reconnected to the public grid and are supplied by the grid.
7. The inverter can start feeding energy into the grid again after performing the grid checks required by the country standard.

Restrictions in emergency power mode

In emergency power mode, some electrical appliances cannot function properly as starting currents are too high (e.g. fridges and freezers). It is recommended to switch off non-essential consumers during emergency power mode.

Switching from grid-connected operation to emergency power mode takes a little while. For this reason, the Fronius Energy Package with emergency power function cannot be used as an uninterruptible power supply, for example for computers.

If no energy is available from the Fronius Solar Battery or the solar modules during emergency power mode, this mode is automatically ended, regardless of whether the public grid is available or not. If sufficient energy becomes available from the solar modules once again, emergency power mode starts again automatically.

If consumption is too high, emergency power mode is interrupted and status code "143 - Emergency power overload" appears. The maximum power in emergency power mode according to the technical data must be observed!

Emergency power and energy saving mode

If the inverter is operating in emergency power mode, energy saving mode is automatically active. Under the following conditions, the battery and the inverter are switched to energy saving mode after a waiting time of 12 minutes:

- The battery is discharged to the minimum state of charge and no energy is coming from the solar modules
- The inverter is in an error state that is not acknowledged automatically (e.g. multiple overload)
- The inverter is set to energy saving mode (standby mode) using the display setting.

If the battery and inverter are in energy saving mode, the system is reactivated by the following:

- Enough energy is available from the solar modules
- The public grid is functioning again
- The battery's POWER switch is switched off and on

More information on energy saving mode can be found in chapter Energy saving mode on page 27

Energy saving mode

General remarks Energy saving mode (standby) is used to reduce the self-consumption of the system. It is available from version 1.4.1-11 of the system monitoring software. Both the inverter and the battery switch to energy saving mode automatically under certain conditions.





Fronius Symo Hybrid

If the battery is empty and no PV energy is available, the inverter switches to energy saving mode. Only the inverter's communication with the Smart Meter and Solar.web is maintained.

Fronius Solar Battery

When the battery is in energy saving mode, the display remains dark. In Solar.web, energy saving mode is indicated by an "i" next to the battery symbol. In the energy balance view, the SOC (State of Charge) of the Fronius Solar Battery is not displayed for the duration of energy saving mode.

Fronius Solar Battery and Fronius Symo Hybrid switch-off conditions

-  \leq min. SoC The state of charge of the battery is lower or the same as the minimum state of charge entered.
-  < 50 W The output of the solar modules is less than 50 W.
-  < 100 W The current charge or discharge power of the battery is less than 100 W.
-  < 50 W Less than 50 W is available to charge the battery. The power of feeding into the public grid is at least 50 W lower than the power currently required in the household network.

If all switch-off conditions are met, the battery switches to energy saving mode within 6 minutes. This time delay ensures that the inverter can at least be restarted.

The inverter automatically switches to energy saving mode after the battery.

Emergency power:

If the emergency power function has been activated, the battery in grid operation does not switch to energy saving mode. Otherwise, the black start (start without grid and PV supply) of the hybrid system could not be ensured.

During emergency power operation and when the state of charge falls below the minimum, the battery switches to energy saving mode.

Fronius Symo Hybrid and Fronius Solar Battery switch-on conditions

If one of the following conditions is met for at least 30 seconds, energy saving mode is ended:

- Energy saving mode is no longer permissible due to changed settings on the inverter website.
- More than 50 W is available to charge the battery. The power of feeding into the public grid is at least 50 W higher than the power currently required in the household network.
- If the dynamic power reduction is set to 0 or if the system is operating in emergency power mode, the power of feeding into the public grid is always lower than the power required in the household network.

In this case there is a separate condition (dynamic power reduction < 300 W or emer-

gency power mode active). If the PV power is above a set threshold (50 W), energy saving mode is ended.

Special case If the inverter has not been operational for 12 minutes (e.g. in the case of a fault), the battery switches to energy saving mode. This prevents the self discharge of the battery.

Indicators on the displays and user interfaces

During energy saving mode:

- the battery display is dark
- the inverter display is dark
- the inverter website can be accessed
- all available data is saved and sent to Solar.web
- the current available data can be viewed on Solar.web

Energy saving mode is shown on the inverter website and in Solar.web by an "i" next to the battery symbol in the system overview.



The battery is in standby mode

Calibration charging

General remarks Determining the exact state of charge (SOC) of the Fronius Solar Battery is important for operation. To ensure this happens, the battery must regularly be charged to 100%. This allows the SOC value to be calibrated.

Calibration charging occurs automatically during operation after several charge and discharge cycles. When calibration charging is carried out depends on two crucial factors:

- Average state of charge
- Energy throughput of the battery

As these factors are extremely weather dependent, the time of a calibration charge can vary depending on the time of year. The following description of calibration charging is valid from version v1.4.1-12 of the Fronius system monitoring software.

Benefits of calibration charging Natural differences in the individual cell capacities and the small amount of self discharge that occurs in all batteries cause the cell voltages to diverge. This makes the SOC value less precise, which has an influence on operation. If no steps are taken, the battery may become damaged.

The cyclic calibration charging brings all cells in the battery to the same state of charge and calibrates the SOC value. This ensures a long service life of the battery cells.

Conditions for the start of calibration charging One charge and discharge cycle corresponds to an energy throughput of 48 Ah per battery module. Calibration charging occurs cyclically according to the following conditions:

- After 3 full charge and discharge cycles and a SOC of 80%
- After 5 full charge and discharge cycles and a SOC of 50%
- After 7 full charge and discharge cycles, independent of the SOC

For newly installed systems and for module replacement or expansion, a calibration charge is started automatically after 30 minutes.

Calibration charging procedure Calibration charging primarily occurs with the entire PV power. If insufficient PV energy is available, energy is drawn from the public grid. This is also the case even if the "Battery charging from DNO grid" function is deactivated, as this is a critical requirement.

The SOC is calculated per battery module. For this reason, each battery module must reach a SOC of 100%.

Calibration process

1. The start conditions must be fulfilled
2. The battery is charged to 100% with a minimum current of 6.5 A or the total PV power.

3. So that a SOC of 100% can be reached for each battery module, one of the following two conditions must be fulfilled for at least 2 minutes (for each cell in every battery module):
 - Minimum cell voltage ≥ 3.45 V and current < 100 mA
 - Minimum cell voltage > 3.5 V independent of current
4. When a battery module reaches one of these conditions, the current is limited to prevent an overload. A current in the two-digit mA range flows over a bypass resistor
5. Unneeded PV power is reused directly
6. Once all cells in all battery modules have fulfilled one of the two conditions, the SOC is set to 100% and calibration charging is complete.

Duration of calibration charging

Due to tolerances in the cells, they are not always charged and discharged at the same rate. As cells and battery modules are connected in series and the slowest cell determines the charging and discharging duration, some calibration charges need more or less time.

In rare cases, calibration charges or full charge cycles (depending on the time of year, e.g. in the winter months) can lead to large variations in the cell voltages in the battery modules. In calibration mode, one cell charges more quickly than the others. This cell then begins redistribution. The other cells can then only be charged with a reduced charging current. It takes longer for these cells to reach the target value.

If the battery is regularly charged completely, calibration charges are rarely required. The cells are calibrated during every charge with 100% SOC. In the winter months, where there are few full charges and a lower energy throughput, calibration charges can take longer, as higher variations between the battery modules must be redistributed.

Limitations during calibration

- Drawing energy from the battery (discharging) is not possible
- Self-consumption optimisation is disabled while calibration charging is in progress
- Charging from the grid can still occur if the "Battery charging from DNO grid" function is not activated, as this process concerns system-relevant service charging
- Zero feed-in continues according to the standard and service charging can even be started if you wish to expand or replace battery modules during calibration
- Emergency power mode can be started – calibration charging is interrupted

Display during calibration charging

As soon as calibration charging starts, it becomes visible in Fronius Solar.web (current and energy balance view) or on the web interface of the Fronius Symo Hybrid inverter.



In Fronius Solar.web or on the web interface of the inverter, the calibration charge information is displayed in the overview. Clicking on the battery symbol (see the image on the left) displays the information „The battery is in calibration mode“.

In the energy balance display in Solar.web, both the start and end of the calibration charge is displayed by changing the battery status ("Batterie Modus: Normal → Calibrate" and "Batterie Modus: Calibrate → Normal")

The following graphic shows calibration charging in the energy balance view. At the start of calibration charging, the total PV production is used to charge the battery. From the point where one cell is fully charged, only a certain charging current is drawn by the battery. This charging current decreases towards 0 A as the cell voltage increases.



As during normal operation, the status "charging" (CHG) is shown on the battery display and the relevant charging current in ampere is displayed. If the charging current drops to below 0.3 A, 0 A is shown on the display, even though calibration charging continues.

In Fronius Solar.web, the SOC value for the entire battery is displayed. On the battery display, the SOC values of the individual battery modules can be viewed.

Operation

Data communication

Data communication area

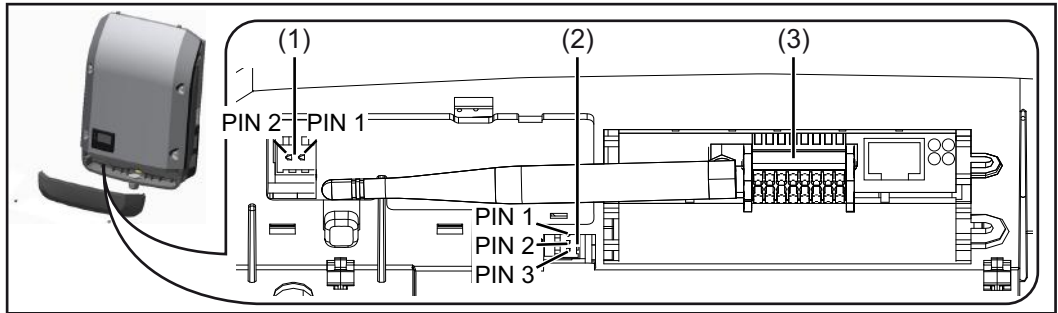

Item	Name
(1)	Switchable multifunction current interface
	Use the 2-pin mating connector supplied with the inverter to connect to the multi-function current interface.
(2)	Floating switch contact with mating connector
	Max. 250 V AC / 4 A AC Max. 30 V DC / 1 A DC Max. 1.5 mm ² (AWG 16) cable cross-section
	Pin 1 = NO contact (normally open) Pin 2 = C (common) Pin 3 = NC contact (normally closed)
	Use the mating connector supplied with the inverter to connect to the floating switch contact.
(3)	System monitoring with WLAN antenna

General

The inverter is fitted with the WLAN-enabled system monitoring and energy management unit (Fronius Datamanager) as standard.

Various functions are included with the Fronius system monitoring, such as:

- Dedicated web page displaying current data and a wide range of settings
- Option of connecting directly to Fronius Solar.web
- Automatic sending of service messages by SMS or e-mail in the event of a fault
- Internet connection via WLAN or LAN
- Ability to control the inverter load by specifying power limit values, minimum or maximum running times or target running times
- Ability to control the inverter via Modbus (TCP)
- Ability to assign control priorities
- Ability to control the inverter by means of connected meters (Fronius Smart Meter)
- Ability to control the inverter via a ripple control signal receiver (e.g. by specifying the reactive power or effective power)
- Dynamic power reduction, taking self-consumption into account
- Ability to control battery charging in line with the control targets set
- Ability to control emergency power mode

Controls, connections and indicators on the system monitoring unit

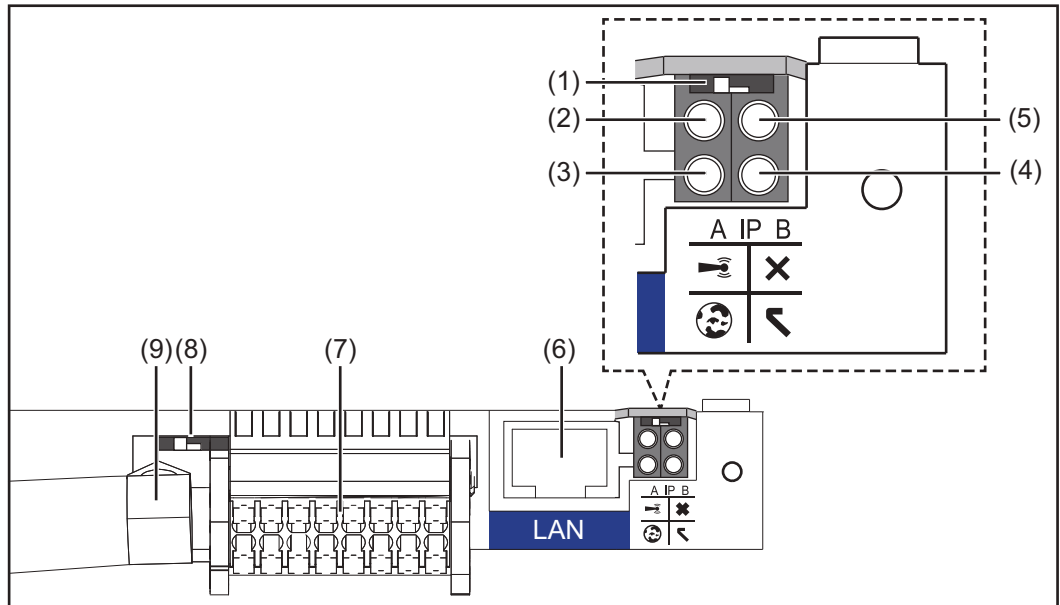

No. Function

(1) IP switch

For switching the IP address:

Switch position A

Default IP address with opening of the WLAN access point

System monitoring uses the set IP address 169.254.0.180 to establish a direct connection to a PC via LAN.

Setting the IP switch to position A also opens an access point to enable a direct WLAN connection to system monitoring.

Access data for this access point:

Network name: FRONIUS_239.XXXXXX

Key: 12345678

System monitoring can be accessed by:

- Using the DNS name "http://datamanager"
- Using the IP address 169.254.0.180 for the LAN interface
- Using the IP address 192.168.250.181 for the WLAN access point

Switch position B

Assigned IP address

System monitoring uses an assigned IP address (factory setting: dynamic (DHCP))

The IP address can be set on the system monitoring web page.

(2) WLAN LED

- Flashing green: System monitoring is in Service mode (IP switch on the system monitoring plug-in card is in position A or Service mode has been activated via the inverter display, the WLAN access point is open)
- Lights up green: WLAN connection established
- Flashing green/red (alternately): WLAN access point has timed out following activation (1 hour)
- Lights up red: no WLAN connection
- Flashing red: faulty WLAN connection

No.	Function
(3)	Solar.web connection LED <ul style="list-style-type: none"> - Lights up green: Fronius Solar.web connection established - Lights up red: Fronius Solar.web connection is required but has not been established - Not lit: no Fronius Solar.web connection is required or the option for sending data to Fronius Solar.web has been deactivated
(4)	Supply LED <ul style="list-style-type: none"> - Lights up green: internal communication system is providing an adequate power supply; system monitoring is ready for use - Not lit: no power is being supplied by the internal communication system - Flashing red: update in progress <p>IMPORTANT! Never interrupt the power supply while an update is in progress.</p> <ul style="list-style-type: none"> - Lights up red: update failed
(5)	Connection LED <ul style="list-style-type: none"> - Lights up green: good connection within the internal communication system - Lights up red: connection within the internal communication system has been interrupted
(6)	LAN connection Ethernet interface, colour-coded blue, for connecting the Ethernet cable
(7)	I/Os Digital inputs and outputs

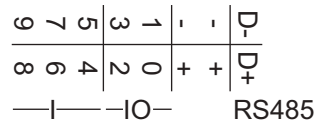
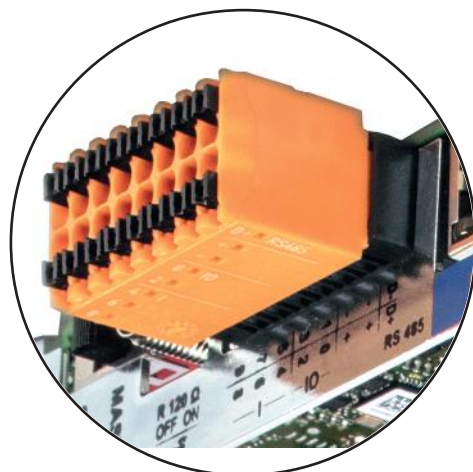

Modbus RTU 2-wire (RS485):

- D- Modbus data -
- D+ Modbus data +

Int./ext. power supply

- GND
- + U_{int} / U_{ext}
 Internal voltage output 12.8 V
 or
 input for an external supply voltage
 >12.8 - 24 V DC (+ 20%)

Digital inputs: 0 - 3, 4 - 9

Voltage level: low = min. 0 V - max. 1.8 V; high = min. 3 V - max. 24 V DC (+ 20%)
 Input currents: dependent on input voltage; input resistance = 46 kOhm

No. Function

Digital outputs: 0 - 3

Switching capacity when power is supplied by the system monitoring plug-in card:
3.2 W in total for all 4 digital outputs

Switching capacity when power is supplied by an external power supply delivering
min. 12.8 - max. 24 V DC (+ 20%), connected to Uint / Uext and GND: 1 A, 12.8 -
24 V DC (depending on external power supply) for each digital output

The connection to the I/Os is established via the mating connector supplied.

(8) Antenna socket

This is where the WLAN antenna is connected

(9) Modbus termination switch (for Modbus RTU)

Internal bus terminator with 120 ohm resistor (yes/no)

Switch in "on" position: 120 ohm terminating resistor active

Switch in "off" position: no terminating resistor active



IMPORTANT! On an RS485 bus, the terminating resistor on the first and last device
must be active. For a detailed description, see the Installation Instructions.

Fronius Hybrid inverter

Controls and indicators

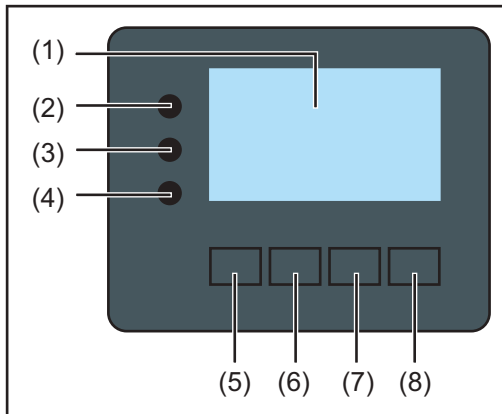

Item	Description
(1)	Display For displaying values, settings and menus

Monitoring and status LEDs

(2)	General status LED Lights up steady: <ul style="list-style-type: none">- If a status code is being displayed on the monitor (red for error, orange for warning)- If the process of feeding energy into the grid is interrupted- During error handling (the inverter waits for an acknowledgement or for an error to be rectified)
(3)	Startup LED (orange) Lights up steady: <ul style="list-style-type: none">- If the inverter is in its automatic startup or self-test phase (as soon after sunrise as the solar modules are delivering sufficient power)- If the inverter has been switched to Standby mode in the Setup menu (= feeding energy into the grid switched off manually)- If the inverter software is being updated
(4)	Operating status LED (green) Lights up steady: <ul style="list-style-type: none">- If the PV system is working correctly after the inverter's automatic startup phase- When system is feeding energy into the grid or is in Storage mode

Function keys – Allocated different functions depending on what has been selected:

(5)	“Left/up” key For navigating to the left and up
(6)	“Down/right” key For navigating down and to the right
(7)	“Menu/Esc” key For switching to the menu level For quitting the Setup menu
(8)	“Enter” key For confirming a selection

The keys operate capacitively. Exposure to water may impair their function. If necessary, wipe the keys dry with a cloth to ensure optimum functionality.

Display

The display is supplied with power via the AC grid voltage and via the PV and battery side. Depending on the setting selected in the Setup menu, the display can be kept on all day.

IMPORTANT! The display on the inverter is not a calibrated measuring device. A slight inaccuracy in comparison with the energy meter used by the power supply company is intrinsic to the system. A calibrated meter will be needed to calculate the bills for the power supply company.

NOV	Menu item
AC Output Power	Parameter declaration
1759 W	Display of values, units and status codes
↑ ↓ ↵	Function key functions

Display areas in Display mode

SETUP [Save]	Save symbol
↑ Standby	Previous menu items
Relay	
[Lock]	Currently selected menu item
↓ Display Setting	Next menu items
Energy Yield	
(*) ↑ ↓ ↵ ↶ ↷	Function key functions

(*) Scroll bar

Save symbol – Appears briefly while the set values are being saved

Fronius Solar Battery

Battery management module

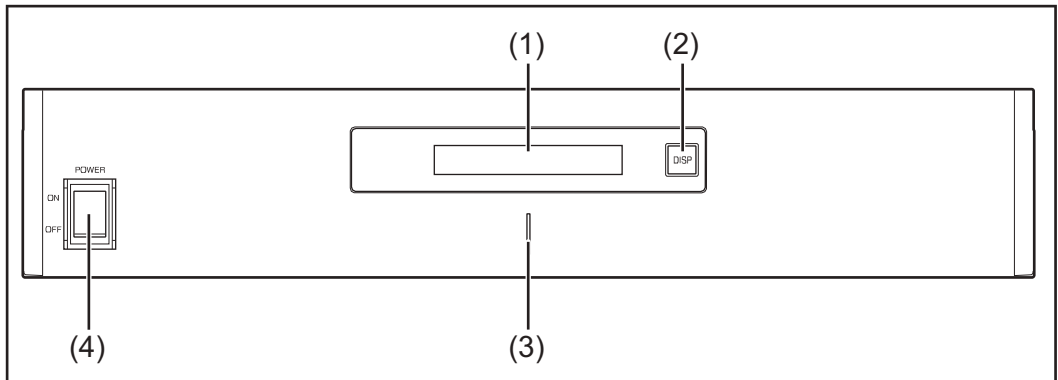

- (1) LCD display**
 Provides information about the status of a module (charging/discharging, total voltage, total current strength, total remaining capacity, number of connected modules, remaining capacity of each module, voltage/temperature etc. of the cell block)
- (2) DISP switch**
 Changes the information shown on the display
- (3) Indicator LED**
 Normal status: Green
 Error: Flashing red
- (4) POWER ON/OFF switch**
 POWER ON: Switches on battery modules and battery management module (operation)
 POWER OFF: Switches off battery modules and battery management module (power supply interrupted)

Battery module

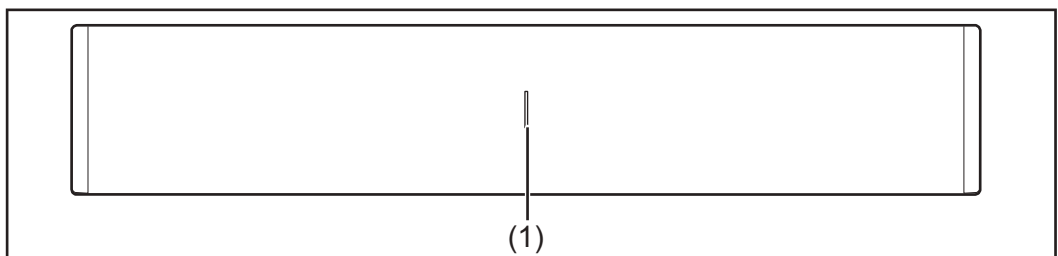

- (1) Indicator LED**
 Normal status: Green
 Error: Flashing red

Display

Press the DISP key to display information.

Display switching diagram

Display overall status of system
 Display status of individual modules

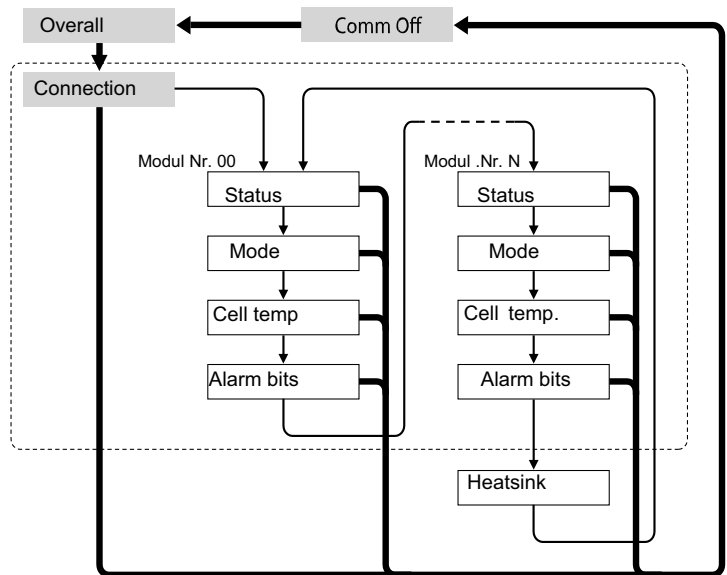

- ➔ Press and hold DISP key
- ➔ Press DISP key
- Nr.N. Means the nth storage module

Tips:

- Hold down DISP key for longer than 3 seconds
- Pressing the DISP key on the "Connection" display takes you back to the "Overall" display.
- "Comm Off Mode" is used for maintenance purposes.

Display types

"Overall" display

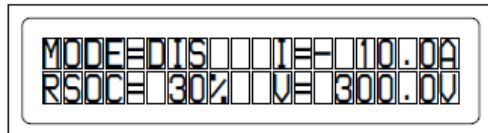

Display	Details	Display
MODE	Charging/discharging and stop status	DIS: Discharging CHG: Charging
RSOC	Remaining system capacity	0% - 100%
I	Total system current strength	-999.9 A to +999.9 A
V	Total system voltage	0.0 V to +999.9 V

"Connection" display



Display	Details	Display
UNIT	Number of connected modules	1 - 16
VER	Version	XXXX

CON	Status of connected modules	In the above example, there are 6 connected modules (no. 00 - no. 05).
-----	-----------------------------	--

"Status" display

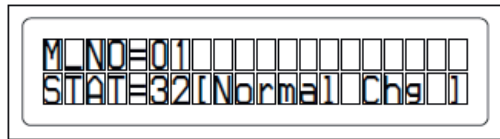

Display	Details	Display
M_NO	Number of modules displayed	00 - 15
STAT	Module status	YX (Y: Current status, X: Previous status) 1X [Pre Charge]: Pre-charging 2X [Initial]: Status at beginning 3X [Normal Chg]: Normal charging 4X [Terminate]: End charging 5X [Normal Dis]: Normal discharging 6X [Over Volt]: Overvoltage 7X [Over Dis]: Deep discharge 8X 9X [Over Temp C]: Overtemperature charging AX [Over Curr C]: Overcurrent charging BX [Over Temp D]: Overtemperature discharging CX [Over Curr D]: Overcurrent discharging DX [Unbalance]: Cell imbalance EX [Chg Suspend]: Charging suspended FX

"Mode, Current, SOC, Voltage" display

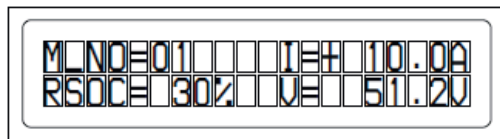

Display	Details	Display
M_NO	Number of modules displayed	00 - 15
RSOC	Remaining module capacity	0% - 100%
I	System module current strength	-999.9 A to +999.9 A
V	System module voltage	0.0 V to +999.9 V

"Cell Temp., Cycle Count" display

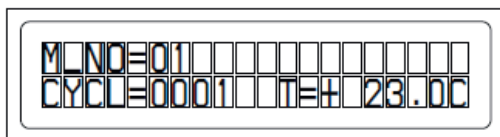

Display	Details	Display
---------	---------	---------

M_NO	Number of modules displayed	00 - 15
CYCL	Number of cycles	0000 - 9999
T	Average temperature of all cells	-99.9 °C to +99.9 °C

"Alarm bits" display

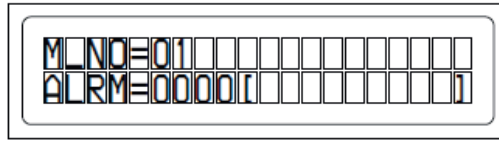

Display	Details	Display
M_NO	Number of modules displayed	00 - 15
ALRM	Module status	8000 [Over Volt]: Overvoltage 4000 [Terminate]: End charging 2000 [Under Volt]: Undervoltage 1000 [Over Curr]: Overcurrent 0800 [Over Temp]: Overtemperature 0400 [0]: 0200 [Resistor]: Resistor alarm 0100 [Unbalance]: Cell imbalance Details displayed if multiple alarms are triggered Example: If both "Over Current" and "Over Temp" are detected, the following message is displayed. A higher bit level takes priority over messages in brackets: "ALRM=1800 [Over Curr]"

"Heatsink Temp" display

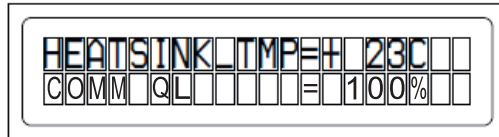

Display	Details	Display
HEAT-SINK_TEMP	Temperature of the heat sink	-40 °C to +119 °C
COMM_QUAL	Internal communication quality	0% - 100%

Data converter connections

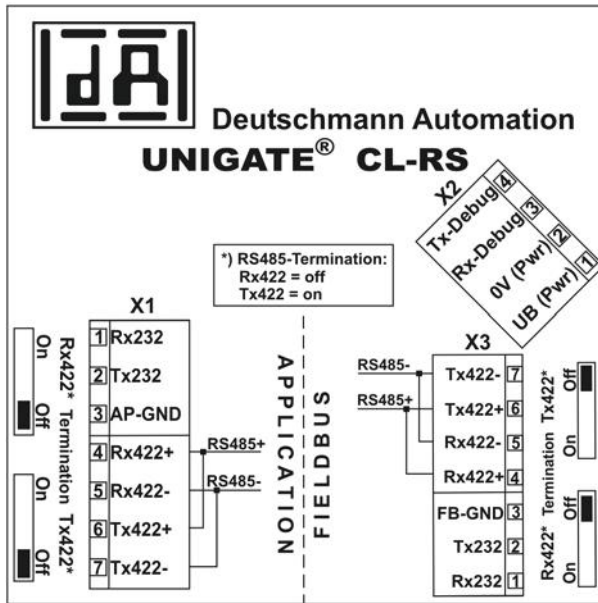

Data converter controls and indicators

Connection to Fronius Solar Battery

Connection to Fronius hybrid inverter

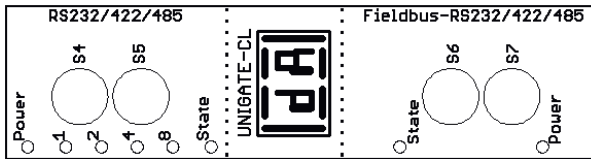

Factory settings:

S4 = 0x0 (hex) = 0000 (binary)

S5 = 0x0 (hex) = 0000 (binary)

S6 = 0x1 (hex) = 0001 (binary)

S7 = 0x4 (hex) = 0100 (binary)

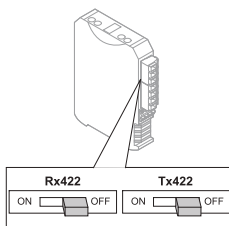

RS485 terminal
Rx422 = off
Tx422 = off

Data converter LED displays

The data converter features 8 LEDs, the meaning of which is explained below:

Fronius Solar Battery RS232/422/485	Fronius hybrid inverter Fieldbus RS232/422/485		
Power LED		Green	Supply voltage on storage side

LED 1/2/4/8 (Error No / Selected ID)		Green	General gateway error
State LED		Red/green	General gateway error
	State LED	Red/green	Inverter interface state
	Power LED	Green	Inverter supply voltage

"Power" LED(Fronius Solar Battery)

This LED is connected directly to the supply voltage of the 1st serial interface (electrical isolation is optionally available for this supply).

"1/2/4/8 (Error No / Selected ID)" LED

If these 4 LEDs and the "State" LED all light up steady red at the same time, the error number is indicated in binary format in accordance with the table in the "Troubleshooting" section.

"State" LED(Fronius Solar Battery)

Lights up green	Status OK
Flashing green	Status OK
Flashing green/red	Status OK
Lights up red	General gateway error (see "Error No." LEDs)
Flashing red	Data converter is in configuration/test mode

"State" LED (Fronius hybrid inverter)

Lights up green	Initialised and started
Flashing green	Initialised
Flashing green/red	-
Lights up red	General bus error (system error 10)
Flashing red	Starts to flash straight after "BusStart" -> Initialisation failed Starts to flash during actual operation -> Data error

"Power" LED (Fronius hybrid inverter)

This LED is connected directly to the supply voltage of the interface.

Navigation at the menu level

Activate display backlighting

- 1 Press any key

The display backlighting is activated.

There is an option under 'Display Settings' in the SETUP menu to set the display backlighting so that it is on all the time or off all the time.

Automatic deactivation of display backlighting / choose 'NOW' menu item

- If no key is pressed for 2 minutes,
- the display backlighting switches off automatically and the inverter goes to the 'NOW' menu item (assuming the display backlighting is set to automatic).
 - The selection of the 'NOW' menu item can happen from any position on the menu level with the exception of the item 'Standby' on the Setup menu.
 - The amount of energy currently fed in is displayed.

Open menu level

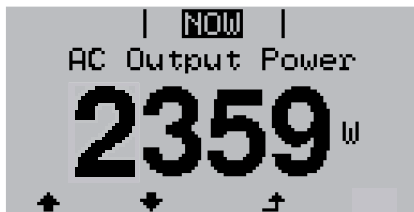

- 1 Press the 'Menu' key

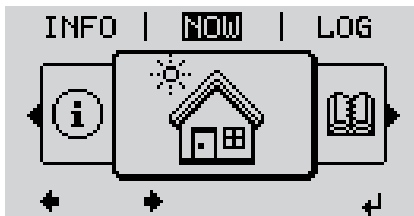

The display switches to the menu level.

- 2 Use the 'Left' or 'Right' keys to select the desired menu item
- 3 Press the 'Enter' key to select the desired menu item

The menu items

- **NOW** displays real-time values
- **LOG** data recorded today, during the current calendar year and since the inverter was first commissioned
- **GRAPH** Day characteristic displays a plot showing the power output during the day. The time axis is scaled automatically. Press the 'Back' key to close the display
- **SETUP** Setup menu
- **INFO** Information about the device and the software

Values displayed under the NOW menu item

Output power (W) – Output power is displayed

AC reactive power (VAr)

Grid voltage (V)

Output current (A)

Grid frequency (Hz)

Solar voltage (V) – Of U PV

Solar current (A) – Of I PV

Time Date – Time and date on inverter

**Values displayed
under the LOG
menu item**

Energy fed in (kWh / MWh)

Energy delivered by the inverter over the period in question

There may be discrepancies compared with values displayed on other measuring instruments because of differences in measuring methods. As far as the billing of the energy fed in is concerned, the only binding display values are those produced by the calibrated measuring instrument provided by the utility company.

Max. output power (W)

Largest amount of energy delivered by the inverter during the period in question

Yield

Amount of money earned during the period in question (currency and conversion factor can be selected in the Setup menu)

Like the "Energy fed in" figure, the yield figure may also exhibit discrepancies compared with other measured values.

The "Setup menu" section explains how to select a currency and charge rate. The factory setting depends on the respective country setup.

Max. grid voltage (V)

Highest grid voltage measured during the period in question

Maximum solar voltage (V)

Highest solar module voltage measured during the period in question

Operating hours

Length of time the inverter has been working (HH:MM)

IMPORTANT! In order for the day and year values to be displayed correctly, the time must be set accurately.

Alternative operating hours

Operating time of the inverter (HH:MM) in alternative mode (emergency power mode).

Menu items in the Set-up menu

Standby

Manual activation / deactivation of Standby mode

- No energy is fed into the grid.
- The Startup LED will show steady orange.
- In Standby mode, no other menu item at menu level can be accessed or adjusted.
- The automatic switchover into the 'NOW' display mode after 2 minutes of keyboard inactivity does not occur.
- Standby mode can only be terminated manually by pressing the 'Enter' key.
- Feeding energy into the grid can be resumed at any time (deactivate 'Standby').

Switching off Standby mode (manually switching off feeding energy into the grid):

1 Select the 'Standby' item

2 Press the 'Enter' key

'STANDBY' and 'ENTER' appear alternately on the display.

Standby mode is now active.

The Startup LED shows steady orange.

Resuming feeding energy into the grid:

'STANDBY' and 'ENTER' appear alternately on the display when in Standby mode.

1 Press the 'Enter' key to resume feeding energy into the grid

The 'Standby' menu item is displayed.

At the same time, the inverter enters the startup phase.

The operating state LED shows steady green when feeding energy into the grid has been resumed.

Relays

Activate relay, relay settings, relay test

Setting range Relay mode / Relay test / Switch-on point* / Switch-off point*

* these are only shown if the 'E-Manager' function has been activated under 'Relay mode'.

Relay mode

for selecting the different functions of the floating switch contact in the data communication area:

- Alarm function
- Active output
- Energy Manager

Setting range ALL / Permanent / OFF / ON / E-Manager

Factory setting ALL

Alarm function:

Permanent / ALL: Switch the floating switch contact for permanent and temporary service codes (e.g. brief interruption to energy being fed into the grid, a service code occurs a certain number of times a day - can be adjusted in the 'BASIC' menu)

Active output:

ON: The floating NO contact is on all the time the inverter is in operation (as long as the display is not dark or is displaying something).

OFF: The floating NO contact is off.

Energy Manager:

E-Manager: Further details on the 'Energy Manager' function may be found in the "Energy Manager" section.

Relay test

Function test to determine whether the floating switch contact switches

Switch-on point (only if 'Energy Manager' function is activated)

for setting the effective power limit beyond which the floating switch contact is switched on

Factory setting	1000 W
Setting range	Switch-off point - max. nominal output of inverter / W / kW

Switch-off point (only if 'Energy Manager' function is activated)

for setting the effective power limit beyond which the floating switch contact is switched off

Factory setting	500
Setting range	0 - Switch-on point / W / kW

**Energy Manager
(under Relay
menu item)**

The "Energy Manager" function can be used to activate the floating switch contact in such a way that it functions as an actuator.

Thus, a consumer that is connected to the floating switch contact can be controlled by specifying a switch-on or switch-off point that depends on the feed-in power.

The floating switch contact is automatically switched off:

- If the inverter is not feeding any power into the grid
- If the inverter is manually switched to Standby mode
- If the effective power is set to < 10% of the nominal output

To activate the "Energy Manager" function, select "E-Manager" and press the "Enter" key. When the "Energy Manager" function is running, the "Energy Manager" symbol will appear in the top left corner of the display:



When the floating NO contact is off (open contact)



When the floating NO contact is on (closed contact)

To deactivate the "Energy Manager" function, select a different function and press the "Enter" key.

Notes on setting up the switch-on and switch-off points

The interface of the energy management relay always uses the output power of the inverter as a reference point, although this will not necessarily match what is generated by the PV system in the case of the hybrid system.

If the difference between the switch-on and switch-off points is too small, or if there are fluctuations in effective power, the result may be multiple switching cycles

To avoid frequent switching on and off, the difference between the switch-on and switch-off points should be at least 100 - 200 W.

When choosing the switch-off point, the power consumption of the connected consumer should be taken into account.

When choosing the switch-on point, the weather conditions and anticipated insolation should also be taken into account.

Application example

Switch-on point = 2000 W, switch-off point = 1800 W

If the inverter is outputting 2000 W or above, then the floating switch contact on the inverter is switched on.

If the inverter output falls to below 1800 W, the floating switch contact is switched off.

Possible applications:

Operating a heat pump or an air-conditioning system using as much self-generated power as possible

Time / Date

Set the time, date and automatic changeover between summer and winter time

Setting range Set time / Set date / Time display format / Date display format / Summer/winter time

Set time

Set the time (hh:mm:ss or hh:mm am/pm – depending on the setting for the time display format)

Set date

Set the date (dd.mm.yyyy or mm/dd/yyyy - depending on the setting for the date display format)

Time display format

For specifying the time display format

Setting range 12hrs / 24hrs

Factory setting Depends on country setup

Date display format

For specifying the date display format

Setting range mm/dd/yyyy / dd.mm.yy

Factory setting Depends on country setup

Summer/winter time

Activate/deactivate automatic changeover between summer and winter time

Setting range on / off

Factory setting on

IMPORTANT! The time and date must be set accurately in order for the day and year values and for the day characteristic to be displayed correctly.

Display settings

Setting range Language / Night mode / Contrast / Illumination

Language

Set language for display

Setting range German, English, French, Dutch, Italian, Spanish, Czech, Slovak, etc.

Night mode

DATCOM night mode; controls DATCOM and display operation during the night or when the DC voltage is insufficient

Setting range	AUTO / ON / OFF
Factory setting	OFF

AUTO: DATCOM mode is always in effect whenever Fronius system monitoring is active.
The display remains dark during the night, but can be activated by pressing any key.

ON: DATCOM mode is always in effect. The inverter supplies 12 V continuously to power the Fronius Solar Net. The display is always active.

IMPORTANT! If DATCOM night mode is set to ON or AUTO when there are Fronius Solar Net components connected, then the inverter's current consumption during the night will increase to around 7 W.

OFF: **IMPORTANT!** If a battery has been connected to the system and activated, Night mode must not be set to OFF.

DATCOM will not run at night, the inverter will not need any AC current in order to supply power to the internal communication system.
The display is switched off during the night and the Fronius system monitoring datalogger is not available.

Contrast

Set the contrast on the display

Setting range	0 - 10
Factory setting	5

Since the contrast is temperature-dependent, it may be necessary to adjust the setting under the "Contrast" menu item when the environmental conditions change.

Illumination

Initial setting for display illumination

The "Illumination" menu item only relates to the display backlighting.

Setting range	AUTO / ON / OFF
Factory setting	AUTO

AUTO: The display backlighting is activated by pressing any key. If no key is pressed for 2 minutes, the display backlighting will go off again.

ON: The display backlighting remains permanently on when the inverter is active.

OFF: The display backlighting is permanently switched off.

Energy yield

Setting
- of the currency
- of the feed-in tariff

Setting range	Currency / Feed-in tariff
---------------	---------------------------

Currency

Set the currency

Setting range 3 characters, A-Z

Feed-in tariff

Set the remuneration rate for energy fed into the grid

Setting range 2 digits, 3 decimal places

Factory setting (depends on country setup)

Fan

To check that the fan is working correctly

Setting range Test fan #1 / Test fan #2 (depending on the device)

- Use the 'Up' and 'Down' keys to select the desired fan
- Testing of the selected fan is initiated by clicking 'Enter'.
- The fan will continue to run until the operator exits the menu by pressing 'Esc'.

SETUP menu item

Initial setting

The inverter is pre-configured and ready to use. There is no need to enter any initial settings before using it to feed energy into the grid, as this is a fully-automated process.

The SETUP menu item allows the initial settings of the inverter to be changed easily to bring it in line, as closely as possible, with the preferences and requirements of the user.

Software updates



NOTE! As a result of software updates, you may find that your device has certain functions that are not described in these operating instructions, or vice versa. Certain illustrations may also differ slightly from the actual controls on your device, but these controls function in exactly the same way.

Navigating the SETUP menu item

Entering the SETUP menu item

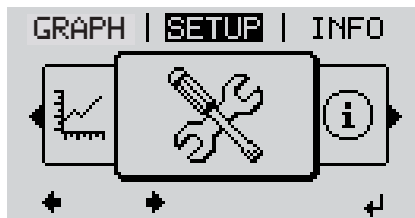

- 1 At the menu level, use the 'Left' or 'Right' keys to select the 'SETUP' menu item
- 2 Press the 'Enter' key

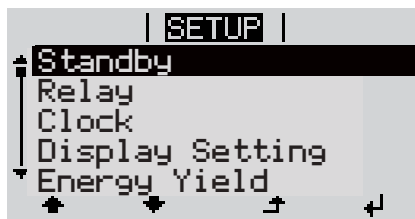

The first entry under the SETUP menu item is displayed: 'Standby'

Scrolling between the entries

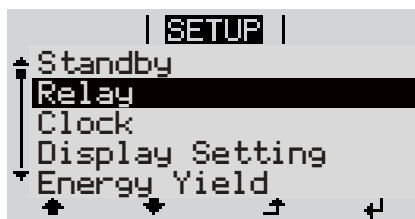

- 3 Use the 'UP' and 'Down' keys to move between the available entries

Exiting an entry

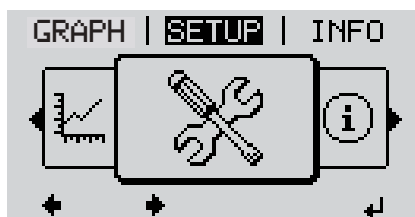

- 4 To exit a menu entry, press the 'Back' key

The menu level appears.

If no key is pressed for 2 minutes:

- The inverter switches from wherever it is on the menu level back to the 'NOW' display mode (exception: 'Standby' Setup menu item).
- The display backlighting goes out.
- The amount of energy currently being fed in is displayed.

Setting entries on the Setup menu, general

- 1 Entering the SETUP menu item
- 2 Use the 'Up' or 'Down' keys to select the desired menu item
▲ ▼
- 3 Press 'Enter'
↵

The first digit of a value to be set flashes:

- 4 Use the 'Up' or 'Down' keys to select a value for the first digit
▲ ▼
- 5 Press 'Enter'
↵

The second digit of the value flashes.

- 6 Repeat steps 4 and 5 until ...

the whole value to be set flashes.

- 7 Press 'Enter'
↵
- 8 Repeat steps 4 - 6 as required for units or other values that are to be set until the appropriate unit or the value flashes.
- 9 Press the 'Enter' key to save and apply the changes.
↵

To discard the changes, press the 'Esc' key.
⬆

The currently selected menu item is displayed.

The available settings are displayed:

- 4 Use the 'Up' or 'Down' buttons to select the desired setting
▲ ▼
- 5 Press the 'Enter' key to save and apply the setting.
↵

To discard the setting, press the 'Esc' key.
⬆

The currently selected menu item is displayed.

Application example: Setting the time

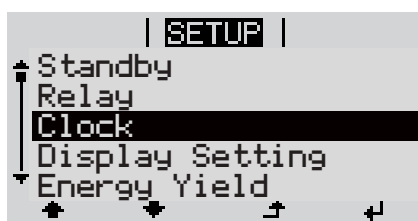

- ▲ ▼ 1 Select "Time / Date" from the Setup menu.
- ↵ 2 Press the "Enter" key.



An overview of the values that can be changed is displayed.

↑ ↓ **3** Use the “Up” or “Down” keys to select “Set time”.

↵ **4** Press the “Enter” key.



The current time appears. (HH:MM:SS, 24-hour clock), the “tens” digit for the hour will flash.

+ - **5** Use the “Up” and “Down” keys to select a value for the “tens” digit of the hour.

↵ **6** Press the “Enter” key.

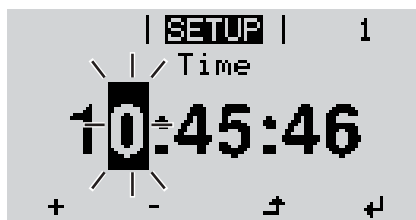

The “units” digit for the hour will flash.

7 Repeat steps 5 and 6 to set the “units” digit for the hour, for the minutes and for the seconds until...



the set time starts flashing.

↵ **8** Press the “Enter” key.



The time is applied and the overview of values that can be changed is displayed.

↑ **4** Press the “Esc” key.

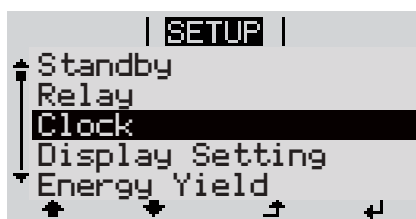

The “Time / Date” item on the Setup menu appears.

The INFO menu item

Measured values	PV ins. Insulation resistance of the photovoltaic system and the storage system
	Ext. lim. External power reduction in per cent e.g. specified by grid operator
	U PV Current PV voltage on the terminals even if the inverter is feeding in no power whatsoever
	GVDPR Grid voltage-dependent power reduction
	Fan #1 Percentage of target output for fan

PSS status	The status of the most recent inverter fault can be displayed. IMPORTANT! Due to the low level of insolation early in the morning and in the evening, the status codes 306 (Power low) and 307 (DC low) are displayed routinely at these times of day. These status codes do not indicate any kind of fault. <ul style="list-style-type: none"> - Press the 'Enter' key to see the status of the power stage set and the most recent fault - Use the 'Up' and 'Down' keys to scroll through the list - Press the 'Back' key to close the status and fault list
-------------------	--

Grid status	The five most recent grid faults can be displayed: <ul style="list-style-type: none"> - Press the 'Enter' key to see the five most recent grid faults - Use the 'Up' and 'Down' keys to scroll through the list - Press the 'Back' key to close the grid fault display
--------------------	---

Device information	For displaying the settings that will be of relevance to a power supply company. The values shown will depend on the country setup or the device-specific settings of the inverter.
---------------------------	---

Display area	General / Country-specific setting / MPP tracker / Grid monitoring / Grid voltage limits / Grid frequency limits / Q-mode / AC power limit / AC voltage derating / Fault Ride Through
--------------	---

General:	Device type Fam.
----------	---------------------

Country-specific setting:	Setup Specified country setup Version Version of country setup Alternative (emergency power) or original country setup activated
---------------------------	--

	Group Group for updating the inverter software
--	---

MPP Tracker:	PV Tracker
Grid monitoring:	<p>GMTi Start-up time of inverter in s</p> <p>GMTr reconnection time in s following a grid fault</p> <p>ULL Mean grid voltage over 10 minutes in V</p> <p>LLTrip Trip time for long-term voltage monitoring</p>
Grid voltage limits:	<p>UILmax Upper inner grid voltage in V</p> <p>UILmin Lower inner grid voltage in V</p>
Grid frequency limits:	<p>FILmax Upper inner grid frequency in Hz</p> <p>FILmin Lower inner grid frequency in Hz</p>
Q-mode:	Current cos phi power factor setting (e.g. Constant Cos(phi) / Constant Q / Q(U) characteristic / etc.)
AC power limit:	<p>Max. P AC Manual power reduction</p>
AC voltage derating:	<p>Status ON / OFF – Voltage-dependent power reduction</p> <p>GVDPRe Threshold at which the voltage-dependent power reduction begins</p> <p>GVDPRe Reduction gradient used to reduce the power, e.g.: 10% per volt above the GVDPRe threshold</p> <p>Message Activates the sending of an info message via Fronius Solar Net</p>
Fault Ride Through:	<p>Status – Default setting: OFF If the function is activated, the inverter does not switch off immediately in the event of a short-term AC voltage dip (outside of the limits specified by the grid supplier), but instead continues to feed in power for a defined period.</p> <p>DB min – Default setting: 90% "Dead Band Minimum" setting in per cent</p> <p>DB max - Default setting: 120% "Dead Band Maximum" setting in per cent</p> <p>k-Fac. - Default setting: 0</p>

Version

Displays the version and serial numbers of the PC boards in the inverter (e.g. for service purposes)

Display area

Display / Display Software / Integrity Checksum / Memory Card
/ Memory Card #1 / Power Stage / Power Stage Software / EMI
Filter / Power Stage #3 / Power Stage #4

Switching the key lock on and off

General

The inverter has a key lock function. When the key lock is active, the Setup menu is not accessible, i.e. the setup data cannot be changed accidentally (or maliciously). The code 12321 has to be entered in order to activate / deactivate the key lock.

Switching the key lock on and off

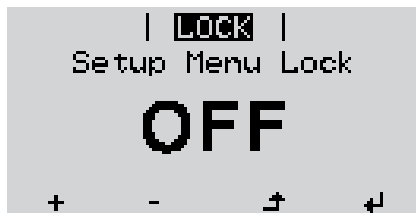
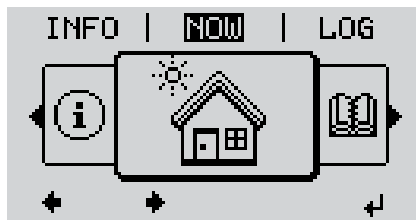

- ↑ **1** Press the 'Menu' key

The menu level appears.

- 2** Press the unassigned 'Menu / Esc' key 5 times



"Access Code" is displayed in the "CODE" menu; the first digit starts flashing.

- + - **3** Enter the code 12321: use the 'Up' and 'Down' keys to select a value for the first digit of the code.

- ↵ **4** Press the 'Enter' key

The second digit starts flashing.

- 5** Repeat steps 3 and 4 for the second, third, fourth and fifth digit of the access code until ...

the selected code starts flashing.

- ↵ **6** Press the 'Enter' key

'Key Lock' is displayed in the 'LOCK' menu.

- + - **7** Use the 'Up' and 'Down' keys to turn the key lock on or off:

ON = key lock is on (the Setup menu is not accessible)

OFF = key lock is off (the Setup menu is accessible)

- ↵ **8** Press the 'Enter' key

The Basic menu

Access the Basic menu

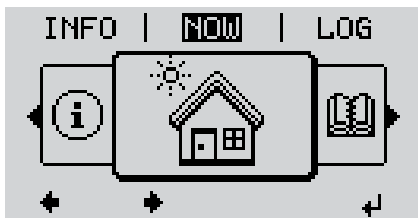

- ↑ **1** Press the "Menu" key

The menu level appears.

- 2** Press the unassigned 'Menu / Esc' key 5 times



'Access Code' is displayed in the 'CODE' menu; the first digit starts flashing.

- + - **3** Enter the code 22742: Use the 'Up' and 'Down' keys to select a value for the first digit of the code

- ↵ **4** Press 'Enter'

The second digit flashes.

- 5** Repeat steps 3 and 4 for the second, third, fourth and fifth digit of the access code until...

the selected code starts flashing.

- ↵ **6** Press 'Enter'

The Basic menu appears.

- + - **7** Use the 'Up' or 'Down' keys to select the desired menu item

- ↵ **8** Press the 'Enter' key to open the desired menu item

- ↑ **9** Press the 'Esc' key to exit the Basic menu

Items on the Basic menu

The Basic menu is used to set the following parameters, which are important for installing and operating the inverter:

MPP Tracker 1

- DC operating mode: MPP AUTO / FIX / MPP USER
 - MPP AUTO: normal operating status; the inverter automatically searches for the ideal operating point
 - FIX: for entering a fixed DC voltage at which the inverter will operate
 - MPP USER: for entering a lower MP voltage above which the inverter will search for its ideal operating point
- Dynamic Peak Manager: ON / OFF
- Fixed voltage: for entering a fixed voltage (150 - 800 V)
- MPPT start voltage: for entering the start voltage (150 - 800 V)

Input signal

- How it works: Ext Sig. / S0-Meter / OFF
Only with the Ext Sig. function selected:
 - Triggering method: Warning (warning shown on display) / Ext. Stop (inverter switches off)
 - Connection type: N/C (normally closed contact) / N/O (normally open contact)
-

SMS / relay

- Event delay:
for entering the time delay after which an SMS is sent or the relay is to switch
900 - 86,400 seconds
 - Event counter:
for entering the number of events that lead to signalling:
10 - 255
-

Insulation setting

- Insulation warning: ON / OFF
 - Threshold warning: for entering a threshold that leads to a warning
 - Threshold fault: for entering a threshold that leads to a fault (not available in all countries)
 - Both the PV system and the Fronius Solar Battery are monitored
-

Temperature warning

For activating/deactivating the overtemperature warning for each event
ON / OFF

TOTAL Reset

Under the LOG menu item, this setting resets the max. and min. voltage values and the max. power of feeding in to zero.

Once the values have been reset, this action cannot be undone.

To reset the values to zero, press the "Enter" key.

"CONFIRM" is displayed.

Press "Enter" again.

The values are reset and the menu is displayed.

Fronius system monitoring

General remarks The Fronius system monitoring feature is a networked datalogger that manages to combine the functions of the Fronius Com Card, the Fronius Datalogger Web, the Fronius Power Control Card and the Fronius Modbus Card on a single plug-in card. The Fronius system monitoring web page offers a rapid overview of the photovoltaic system. It can be accessed via a web browser when there is a direct connection or – if configured to support an indirect connection – over the Internet. Fronius system monitoring is easy to configure and provides automatic alerts. Alerts can be sent via SMS or e-mail.

If the feature is used in conjunction with Fronius Solar.web, current data and archive data can be accessed for a particular photovoltaic system via the Internet or the Fronius Solar.web App without the need for any laborious configuration work. Fronius system monitoring automatically sends the data to Fronius Solar.web.

Prerequisites for operation So that data can be exchanged smoothly over the Internet, you must have a suitable Internet connection:

- For wired Internet solutions, Fronius recommends a download speed of at least 512 kbit/s and a minimum upload speed of 256 kbit/s.
- For solutions that rely on mobile Internet services, Fronius recommends 3G transmission as a minimum, plus a reliable signal.

Even if these specifications are adhered to, there is still no guarantee that everything will run smoothly. High error rates during transmission, variable reception conditions or transmission drop-outs can all have a detrimental effect on the online functionality of Fronius system monitoring. Fronius recommends testing any connections that meet the minimum requirements locally.

Calculating data volumes

General

When using Fronius system monitoring, data is collated that must be transmitted over the internet.

The data volume must be calculated so that the correct internet connection is selected.

The data volume calculation below provides an overview of the data quantities involved when using Fronius system monitoring.

Calculating data volumes

The data volume calculation depends on the number of connected devices in the system monitoring.

The table below provides an overview of the data volume for various configurations and time settings (INV = Fronius Symo Hybrid, SM = Smart Meter, BAT = battery module of the Fronius Solar Battery)

Data volume per day:			
Sent	Configuration	5 min logging	30 min logging
Hourly (06:00 - 20:00)	INV	436 kB	305 kB
	INV + SM	659 kB	349 kB
	INV + SM + 3x BAT	2198 kB	605 kB
	INV + SM + 4x BAT	2556 kB	659 kB
	INV + SM + 5x BAT	2958 kB	750 kB
	INV + SM + 6x BAT	3306 kB	775 kB
	INV + SM + 7x BAT	3485 kB	838 kB
	INV + SM + 8x BAT	4160 kB	920 kB
Daily	INV	30 kB	15 kB
	INV + SM	55 kB	20 kB
	INV + SM + 3x BAT	228 kB	49 kB
	INV + SM + 4x BAT	262 kB	53 kB
	INV + SM + 5x BAT	305 kB	63 kB
	INV + SM + 6x BAT	344 kB	68 kB
	INV + SM + 7x BAT	388 kB	73 kB
	INV + SM + 8x BAT	426 kB	83 kB

Data volume per month:			
Sent	Configuration	5 min logging	30 min logging
Hourly (06:00 - 20:00)	INV	13 MB	10 MB
	INV + SM	20 MB	11 MB
	INV + SM + 3x BAT	67 MB	19 MB
	INV + SM + 4x BAT	78 MB	20 MB
	INV + SM + 5x BAT	90 MB	23 MB
	INV + SM + 6x BAT	101 MB	24 MB
	INV + SM + 7x BAT	106 MB	26 MB
	INV + SM + 8x BAT	126 MB	28 MB

Data volume per month:			
Sent	Configuration	5 min logging	30 min logging
Daily	INV	1 MB	1 MB
	INV + SM	2 MB	1 MB
	INV + SM + 3x BAT	7 MB	2 MB
	INV + SM + 4x BAT	8 MB	2 MB
	INV + SM + 5x BAT	10 MB	2 MB
	INV + SM + 6x BAT	11 MB	3 MB
	INV + SM + 7x BAT	12 MB	3 MB
	INV + SM + 8x BAT	13 MB	3 MB

A data volume of approx. 500 kB per hour is required to view the system on Fronius Solar.web or the Fronius Solar.web App.

A certain data volume is also required to update the Fronius system monitoring firmware. This data volume depends on the size of the update package and therefore cannot be considered in the advance data volume calculation.

If data is sent via a third-party service (e.g. push service), a large quantity of data may be involved.

IMPORTANT! Fronius recommends a flat rate data connection to avoid high connection charges.

General information for the network administrator

Prerequisites



NOTE! Knowledge of networking systems is required in order to configure Fronius system monitoring for the network.

If you are integrating Fronius system monitoring into an existing network, you must adapt the address settings in line with the network.

For example: Network address space = 192.168.1.x, subnet mask = 255.255.255.0

- An IP address of between 192.168.1.1 and 192.168.1.254 must be assigned to Fronius system monitoring.
- The selected IP address must not be in use on the network already.
- The subnet mask must match that of the existing network (e.g. 255.255.255.0).

If you want Fronius system monitoring to send service messages or to transmit data to Fronius Solar.web, you must enter a gateway address and a DNS server address. Fronius system monitoring uses the gateway address for the purpose of establishing an Internet connection. An example of a suitable gateway address would be the IP address of the DSL router.

IMPORTANT!

- Fronius system monitoring must never be assigned the same IP address as the PC/laptop itself!
- Fronius system monitoring is not capable of connecting to the Internet on its own. In the case of a DSL connection, a router has to establish the Internet connection.

General firewall settings

In order to be able to perform the various functions offered by Fronius system monitoring, you must adjust the following firewall settings:

	49049/UDP output
Sending of service messages	x
Connection to Fronius system monitoring established via Fronius Solar.web	x

Service messages are sent via Fronius Solar.web.

Configure the firewall so that data can be sent from the Fronius system monitoring IP address to port 49049/UDP of "fdmp.solarweb.com".

DSL routers usually allow data to be sent over the internet and so do not normally have to be configured for this purpose.

To enable access to the web interface of Fronius system monitoring from outside the LAN:

- Configure the network router so that requests on port 80/TCP are forwarded to Fronius system monitoring.

Using Fronius Solar.web and sending service messages

An Internet connection is required if you want to use Fronius Solar.web or to send service messages.

Fronius system monitoring is not capable of connecting to the Internet on its own. In the case of a DSL connection, a router has to establish the Internet connection.

Installing Fronius system monitoring – Overview

Safety



WARNING! Operating the equipment incorrectly can cause serious injury and damage. Do not use the functions described until you have thoroughly read and understood the following documents:

- these operating instructions
- all the operating instructions for the system components, especially the safety rules



NOTE! Knowledge of networking systems is required in order to install Fronius system monitoring.

Using for the first time



NOTE! The Fronius Solar.web App makes it much easier to set up Fronius system monitoring when using it for the first time.
The Fronius Solar.web App is available in the relevant App store.

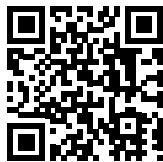

Alternatively,

visit „<https://wizard.solarweb.com>“

IMPORTANT! In order to establish a connection to Fronius system monitoring, the end device in question (e.g. laptop, tablet, etc.) must be set up as follows:

- "Obtain IP address automatically (DHCP)" must be activated

- 1 Switch the device to Service mode
 - Activate the WiFi Access Point via the Setup menu on the inverter

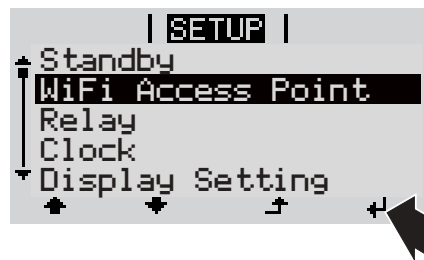

The inverter establishes the WLAN access point. The WLAN access point remains open for 1 hour.

Installation using the Solar.web App

- 2 Download the Fronius Solar.web App.



- 3 Run the Fronius Solar.web App.

Installation using a web browser

- 2 Connect the end device to the WLAN access point.

SSID = FRONIUS_239.xxxxx (4 - 8 digits)

- Search for a network with the name "FRONIUS_239.xxxxx".
- Establish a connection to this network.
- Enter the password 12345678.

(Alternatively, connect the end device and inverter using an Ethernet cable.)

- 3 Enter the following in the browser:
<http://datamanager>
 or
 192.168.250.181 (IP address for WLAN connection)
 or
 169.254.0.180 (IP address for LAN connection).

The Setup wizard start page is displayed.

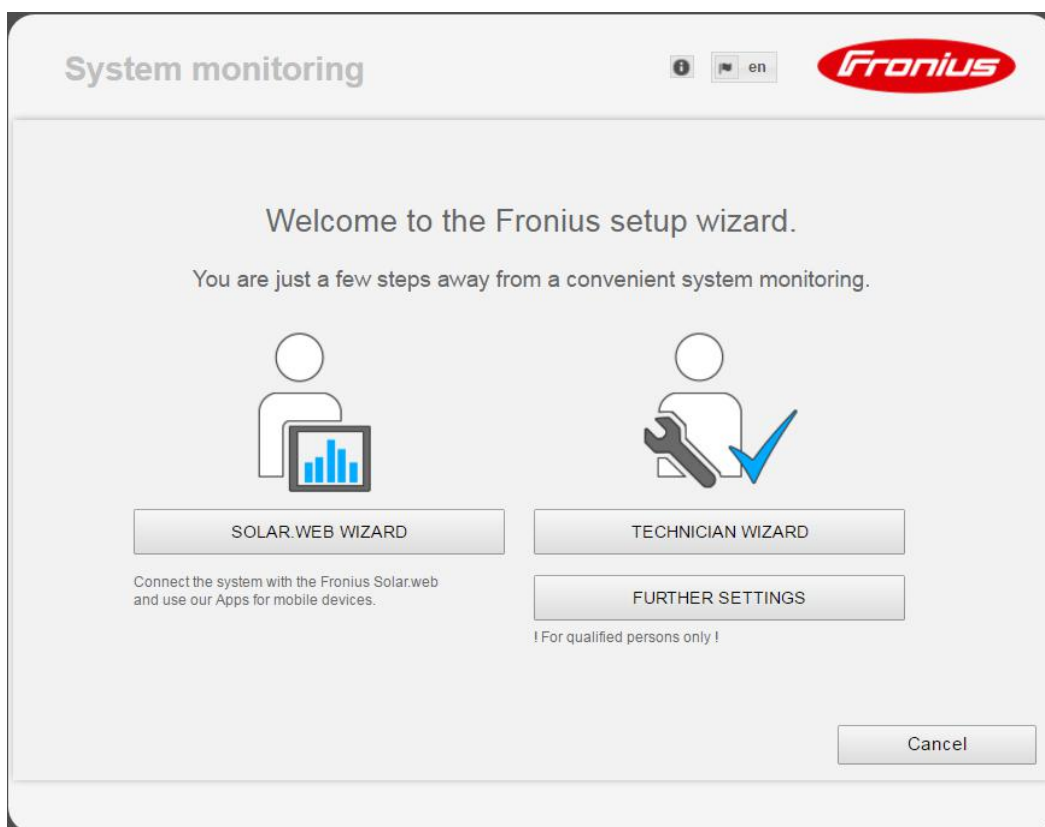

If you run the technician wizard, always remember to make a note of the assigned service password. This service password is necessary for making settings in the "System overview" and "PSC Editor" menus as well as for advanced battery settings. If the technician wizard is not run, no specifications regarding power reduction are set and hybrid mode is not possible (charging and discharging of the Fronius Solar Battery).

- 4 Run the technician wizard and follow the instructions.

5 Run the Solar Web wizard and follow the instructions.

The Fronius Solar.web homepage
or
the Fronius system monitoring web page is displayed.

Information to help you work through the Solar Web wizard

The solar web wizard consists of 5 steps:

1. General

General system data (e.g. system name) is entered here

2. Service password

Enter (and make a note of) the service password

3. IO assignment

Settings for the IO interface are entered (see also General for IO assignment on page 97)

4. System overview

Settings for the entire PV system are entered (see also System overview on page 110)

5. Dynamic power

Settings for dynamic power reduction are entered (see also EVU Editor – Dynamic power reduction on page 115)

Once you have worked your way through the Solar Web wizard, an automatic process is triggered to calibrate all the components. This involves charging the Fronius Solar Battery fully. After that, the system automatically starts in the set operating mode.

This calibration charging process is also performed automatically during actual operation after a number of charging and discharging cycles. When this calibration charge is performed depends on a number of different factors, such as the average state of charge or the energy throughput through the battery. The time can therefore vary depending on the time of year as well.

If the "permit battery charging from PSC grid" setting is deactivated, this calibration charging process relies exclusively on energy from the photovoltaic system when operating under normal conditions. Depending on the insolation conditions and size of the systems concerned, the charging process can take a very long time.

If the "permit battery charging from PSC grid" setting is activated, the calibration charging process is performed by drawing a constant current from the photovoltaic system and PSC grid.

IMPORTANT! The automatic process for fully charging the battery may result in energy being drawn from the PSC grid. The process can take several hours and cannot be aborted.

Testing emergency power mode



NOTE! During grid-connected operation, the inverter recognises and stores the direction of phase rotation in the household network. If the inverter is immediately operated in emergency power mode without first establishing a grid connection, no information is available regarding the direction of rotation. The inverter will feed in power with a default direction of rotation, which can lead to faults in three-phase consumption in the household network.

Emergency power mode should be tested once it has been installed and set up for the first time. A battery state of charge of over 30% is recommended when in test mode.

Connecting to Fronius system monitoring via a web browser

General remarks A connection to Fronius system monitoring via a web browser is the ideal choice if there are lots of PC users who need to access the latest system values over the same LAN (e.g. company networks, schools, etc.).

The Fronius system monitoring web page shows the current power flow in the hybrid system.

- Prerequisites**
- LAN or WLAN connection as a minimum
 - Web browser (e.g. Microsoft Internet Explorer IE >= 9.0, Firefox 4, Google Chrome 27.0, etc.)
 - PC/laptop on the same network segment as Fronius system monitoring

Establishing a connection to Fronius system monitoring via a web browser

- 1 Open the web browser.
- 2 In the address field, enter the IP address or the host name and domain name of the Fronius system monitoring.

The Fronius system monitoring web page appears.

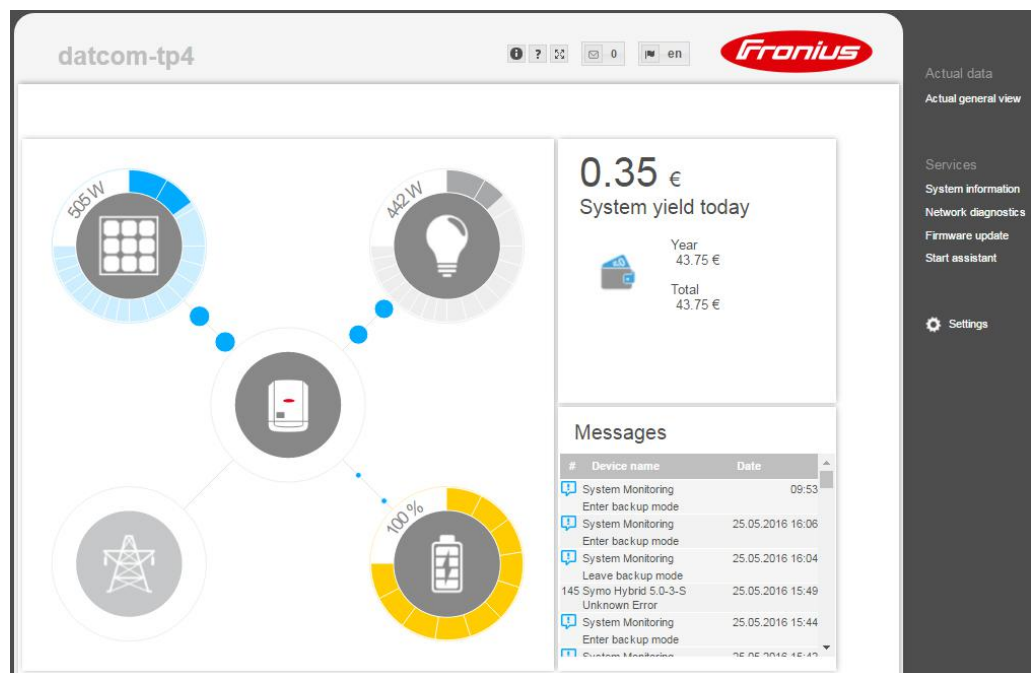

Connecting to Fronius system monitoring established via the Internet and Fronius Solar.web

General remarks Archive and current data for a photovoltaic system can be accessed from anywhere in the world (provided that you have Internet access) by setting up a connection to Fronius system monitoring via the Internet and Fronius Solar.web.
With this setup, you can also invite other users to view the photovoltaic system data as guests and you can compare several systems with one another.

Functional description Fronius system monitoring is connected to the Internet (e.g. via a DSL router). Fronius system monitoring logs into Fronius Solar.web at regular intervals and sends the saved data on a daily basis.
Fronius Solar.web can actively make contact with Fronius system monitoring, e.g. for the purpose of displaying up-to-date data.

Prerequisites

- Internet access
- Web browser

IMPORTANT! Fronius system monitoring is not capable of connecting to the Internet on its own. In the case of a DSL connection, a router has to establish the Internet connection.

- The photovoltaic system must be registered with Fronius Solar.web.
- Current data can only be accessed in Fronius Solar.web if “Send actual data to Fronius Solar.web” is set to “Yes” under “Fronius Solar.web” in the settings for Fronius system monitoring.
- In order for archive data to be accessed in Fronius Solar.web, “Send archive data to Fronius Solar.web” must be set to “daily” or “hourly” for Fronius system monitoring.

Accessing Fronius system monitoring data via the Internet and Fronius Solar.web To use Fronius Solar.web for the purpose of accessing current data and archive data recorded by Fronius system monitoring, proceed as follows:

1 Start Fronius Solar.web: <http://www.solarweb.com>

For detailed information on Fronius Solar.web, see the online help system.

Current data, services and settings offered by Fronius system monitor- ing

The Fronius system monitoring web page

Fronius system monitoring web page – Overview

The Fronius system monitoring web page shows the following data:

- (1) Additional settings
- (2) System overview: displays the current power flow on the hybrid system
- (3) System yield overview
- (4) Overview of recent status codes
- (5) System information, network diagnostics, firmware update
- (6) The Settings menu

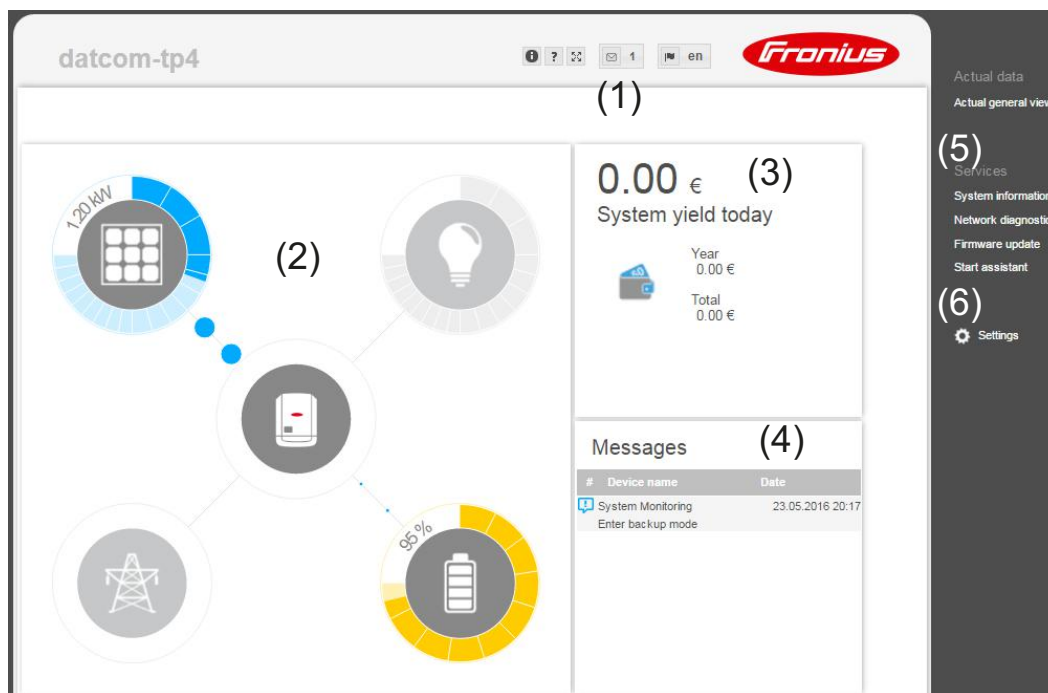

The Settings menu

When you click "Settings", the Settings menu appears on the Fronius **system monitoring** web page.

The "Settings" menu is where you configure Fronius system monitoring.



Setting and viewing "General" menu items

- 1 Establish a connection to Fronius system monitoring.
- 2 Click "Settings".
- 3 Click the required menu item.

The relevant menu item opens.

- 4 View the menu item or edit it as required.
- 5 If applicable, click the button for implementing the setting (e.g. Save, Synchronise, etc.)

The edited data is applied.

* Selected menu item

** These menu items are protected by the service password. Settings within these menus may affect the functionality of the inverter.

Additional setting options

On the Fronius system monitoring web page, the following additional setting options are available on the top right-hand side:



i System information:
Datalogger ID, software version, hardware version, Fronius Solar.web connection

? Help:

- Commissioning the LAN
- Commissioning the WLAN
- Software operating instructions
- Fronius Solar channel

Expand contents:
Hides the area containing the Actual data/Settings menus

0 Display messages

de Language:
For setting the language

The Fronius system monitoring web page is either displayed in the same language as the current browser or in the language that was last selected.

Services – System information

System information

System information

Datalogger ID	
Circuit board version	2.4D
Software version	1.3.1-3
System time	Jun 14 2016, 15:12:02 CEST
Uptime	0 d, 20 h, 29 min, 27 sec.
User agent	Mozilla/5.0 (Windows NT 6.1; WOW64) AppleWebKit/537.36 (KHTML, like Gecko) Chrome/51.0.2704.84 Safari/537.36
Gateway	
DNS server	
LED states	   
LAN interface	
IP address	
Subnet mask	
MAC address	
WLAN interface	
IP address	
Subnet mask	
MAC address	
GPIO	
IO-Name	I/O0 I/O1 I/O2 I/O3 I4 I5 I6 I7 I8 I9
IO-Direction	OUT OUT IN IN IN IN IN IN IN IN
IO-State	off off off off off off off off off off

Components

Inverter			
No	Device type	PMC	Serial number
1	Fronius Symo Hybrid 5.0-3-S	[4,071,474]1.2D__ RECERBO-HY R	

Meter			
No	Device type	Location of the meter	Serial number
1	Smart Meter 63A	Feed-in point (Primary meter)	

Battery		
Serial number		
MODEL	Fronius Solar Battery	
Module	Serial number	Battery capacity
Module 1		1200 Wh
Module 2		1200 Wh
Module 3		1200 Wh
Module 4		1200 Wh
Module 5		1200 Wh
Module 6		1200 Wh
Module 7		1200 Wh
Module 8		1200 Wh

Note: This device contains open source software.
For detailed information about the software being used and the requirements of the corresponding source code, please contact Fronius Tech Support.

- All settings except for the network
- All settings

'Datalogger restart' button
For restarting Fronius system monitoring

'Reset to factory settings' button

'All settings except for the network' option

For resetting Fronius system monitoring to the factory settings.

The network settings and all the items protected by the service user (PSC editor, meter settings and the service password) are retained.

'All settings' option

For resetting Fronius system monitoring and the network settings to the factory settings.

All the items protected by the service user (PSC editor, meter settings and the service password) are retained.

IMPORTANT! If Fronius system monitoring is reset to the factory settings, it is essential to check the time and date settings.

Services – Network diagnostics

Network diagnostics

Under Services / Network diagnostics, you will find various functions that are useful for diagnosing and resolving network problems. You can execute ping and traceroute commands.

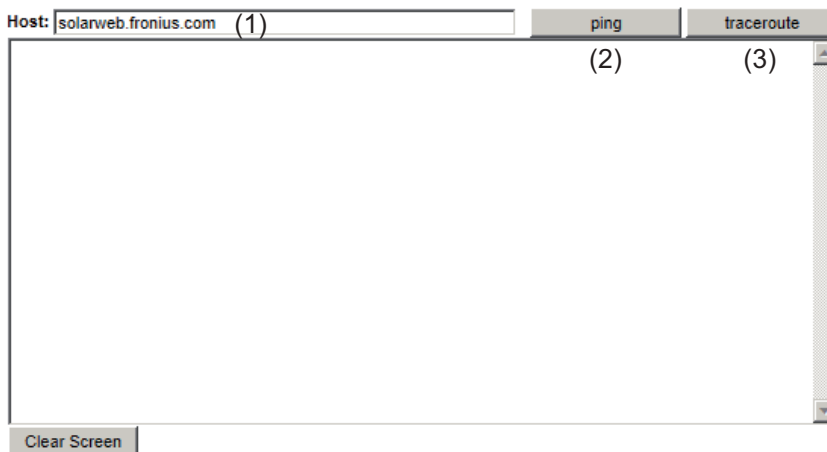

Ping command

A ping command allows you to check whether a host can be reached and how long the data transfer process takes.

Sending a ping command:

- 1 Enter a host name or an IP address in the “Host:□” field (1).
- 2 Click the “ping” button (2).
 - The ping command is sent.
 - The identified data is displayed.

Traceroute command

You can use a traceroute command to determine which intermediate stations the data passes through on its way to the host.

Sending a traceroute command:

- 1 Enter a host name or an IP address in the “Host:□” field (1).
- 2 Click the “traceroute” button (3).
 - The traceroute command is sent.
 - The identified data is displayed.

Services – Firmware update

General

The firmware of the Fronius system monitoring datalogger can be updated under Services / Firmware update. A firmware update can be performed via a LAN or over the Web.

Configuration

- (1) Automatic update search (2)
- (3) allow installing Updates automatically
daily at :
- (4) Enable remote update
- (5) Use proxy server for Web update

Update

- (6) Update via Web Update via LAN (7)

(8)

- (1) Automatic update search
- (2) "check now" button (search manually for updates)
- (3) allow installing Updates automatically daily at
- (4) Enable remote update
- (5) Use proxy server for Web update

(5) Use proxy server for Web update

(5a) Proxy server:

(5b) Port:

(5c) User:

(5d) Password:

- (5a) Field for entering the proxy server
- (5b) Field for entering the port
- (5c) Field for entering the user
- (5d) Field for entering the password

- (6) Update via Web
- (7) Update via LAN

Update via Web Update via LAN

(7)

(7a) IP address of your computer: . . .

- (7a) Field for entering the IP address
- (8) "Run update" button
For starting the update process

Searching for updates automatically

IMPORTANT! An Internet connection is required to use the "Automatic update search" function.

If the “Automatic update search” (1) option is activated, Fronius system monitoring automatically searches for updates once a day. If new updates are available, a corresponding message is displayed alongside the additional setting options on the Fronius system monitoring web page.

Firmware Update

Configuration

(1) Automatic update search

Searching for updates manually

If the “Automatic update search” option is deactivated, the system does not search for updates automatically.

1 To search for updates manually, press the “check now” button (2).

Firmware Update

Configuration

Automatic update search (2)

Updating the firmware via the Web

- 1** Use your web browser to open the Fronius system monitoring web page.
- 2** Open “Firmware update” under “Services”.
- 3** Select “Update via Web”.
- 4** Click the “Run update” button.

A confirmation prompt for the update is displayed.

5 Click the “Yes” button.

The update is performed and progress is indicated in the form of a bar and as a percentage.

6 Once the update has been successfully completed, click the “Apply/Save” button.

If the connection to the server fails:

- Deactivate the firewall for the amount of time required to complete the update.
- Try again.

IMPORTANT! If a proxy server is being used to establish the Internet connection:

- You must activate the “Use proxy server for Web update” option.
- You must enter the data required.

Updating the firmware via a LAN

- 1** Establish the LAN connection between the PC/laptop and Fronius system monitoring.
- 2** Download the latest firmware from the Fronius homepage.
- 3** Once it has been downloaded, run the update file on the PC/laptop.

This starts a web server so that Fronius system monitoring can download the necessary files from it.

4 Use your web browser to open the Fronius system monitoring web page.

- 5 Open "Firmware update" under "Services".
- 6 Select "Update via LAN".
- 7 Enter the IP address of the PC/laptop.
- 8 Click the "Run update" button.

A confirmation prompt for the update is displayed.

- 9 Click the "Yes" button.

The update is performed and progress is indicated in the form of a bar and as a percentage.

- 10 Once the update has been successfully completed, click the "Apply/Save" button.

The "Supply LED" lights up steady green again to indicate that the update process is complete.

If the connection to the server fails:

- Deactivate the firewall for the amount of time required to complete the update.
- Try again.

Services – Starting the wizard

Starting the wizard

You can access and run the setup wizard again by selecting "Assistenten aufrufen" [Start wizard].

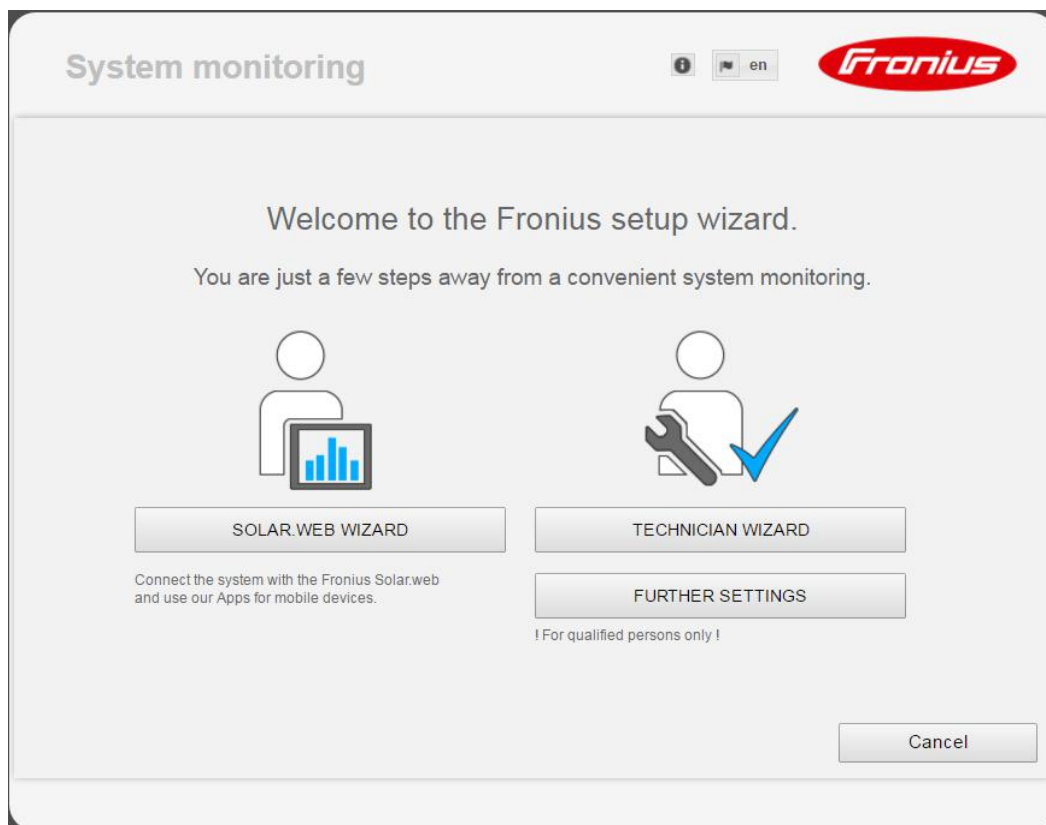

SOLAR WEB WIZARD

For connecting the system to Fronius Solar.web and Fronius apps for mobile devices

TECHNICIAN WIZARD (for trained personnel or specialists only)

For system settings

WEITERE EINSTELLUNGEN [ADDITIONAL SETTINGS] (for trained personnel or specialists only)

All settings for Fronius system monitoring Click the "SOLAR WEB WIZARD" button to return to the original page.

Settings – General

General

General

(11) (12)

(1) System name *

Yield

Feed-in tariff (2) € (EUR) (3) /kWh

Grid supply tariff (4) /kWh

System time

Date / time * (5) (6) : (7)

(8)

Time zone settings

Time zone * (9) (10)

You can enter the name of the system under "System name" (1). Under "Yield", you can enter the charge rate per kWh ("Feed-in tariff") (2), the currency (3) and the procurement costs per kWh ("Grid supply tariff") (4) for calculating the yield. The yield figure is displayed in the current general view.

Under "System time", you can enter the date (5), hour (6) and minutes (7). Click the "synchronisation" button (8) to adapt the time that is displayed in the input fields of the Fronius system monitoring web page to the time on the computer operating system. To apply the time, click the "Apply/Save" button (11).

Under "Time zone settings", you can set the region (9) and the town/city (10) for the time zone.

- (11) "Apply/Save" button
- (12) "Cancel/Discard entry" button

* Fields marked with an asterisk * are mandatory.

Settings – Passwords

General remarks Access to Fronius system monitoring is controlled by assigning passwords. There are 3 different types of password available for this purpose:

- The administrator password
- The service password
- The user password

Passwords

Passwords

(4)

User name (1)

Old password *

Password *

Repeat password *

(4)

User name (2)

Old password *

Password *

Repeat password *

(3) Protect your system monitoring from unauthorized read access.

(1) Administrator password, user name = admin

The administrator password is set during the commissioning process and grants the user read permissions and setting permissions for Fronius system monitoring. The user can open the Settings menu and make all the settings apart from the ones for “System overview”, “EVU Editor” and “Advanced battery settings”.

If an administrator password has been set, the user must enter the user name and password for Fronius system monitoring in order to open the Settings menu.

(2) Service password, user name = service

The service password is usually assigned by the service engineer or system installer when running the Setup wizard and it provides access to system-specific parameters. The service password is required to alter meter and EVU Editor settings. The “System overview”, “EVU Editor” and “Advanced battery settings” menu items cannot be accessed unless a service password has been assigned.

(3) As soon as the selection box is activated, the user password is displayed, user name = user.

Protect your system monitoring from unauthorized read access.

(3)



(4)

User name

Password *

Repeat password *

If a user password has been assigned, the user only has read permissions for Fronius system monitoring. The user is not able to open the “Settings” menu.

If a user password is assigned, the user is required to enter the user name and password whenever they want to establish a connection to Fronius system monitoring.

(4) “Apply/Save” button

Settings – Network

General

The Network menu item is used to define whether the Internet connection is to be established via LAN or via WLAN.

IMPORTANT! If the IP address is obtained statically, a gateway and a DNS server must be entered for the selected connection mode (Internet via WLAN or LAN).

Network

Connection mode

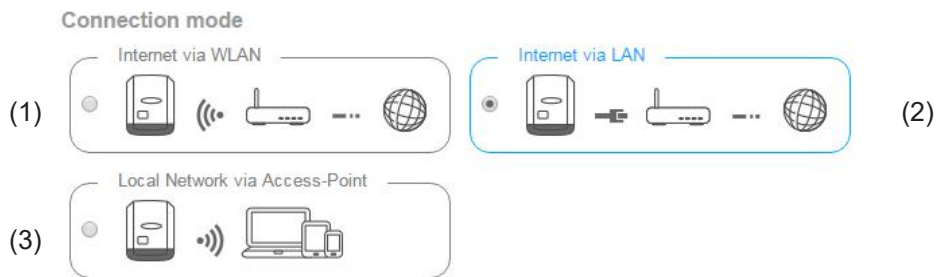

- (1) Internet connection via LAN
- (2) Internet connection via WLAN
- (3) Local network via access point

LAN settings

(4) (5)

Get address static dynamic

Host name (6)

IP-Address (7)

Subnet-mask (8)

Gateway (9)

DNS-Server (10)

- (4) Obtain IP address statically
The user enters a fixed IP address for Fronius system monitoring and also defines the subnet mask, the gateway address and the DNS server address (from the provider) manually.
- (5) Obtain IP address dynamically
Fronius system monitoring fetches the IP address from a DHCP server (DHCP = Dynamic Host Configuration Protocol).
The DHCP server must be configured so that the same IP address is always assigned to Fronius system monitoring. This means that you always know which IP address can be used to reach the Fronius system monitoring datalogger.
If the DHCP server supports the DNS dynamic updates function, a name can be assigned to Fronius system monitoring in the "Host name" field. As a result, the connection to Fronius system monitoring can be established using the name instead of the IP address.
For example: Host name = sample_system, domain name = froni-us.com
Fronius system monitoring can be reached via the address "sample_system.froni-us.com".
- (6) Field for entering a host name when the IP address is obtained dynamically
- (7) Field for entering the IP address in the case of a static IP address
- (8) Field for entering the subnet mask in the case of a static IP address
- (9) Field for entering the gateway in the case of a static IP address
- (10) Field for entering the DNS server in the case of a static IP address

WLAN settings

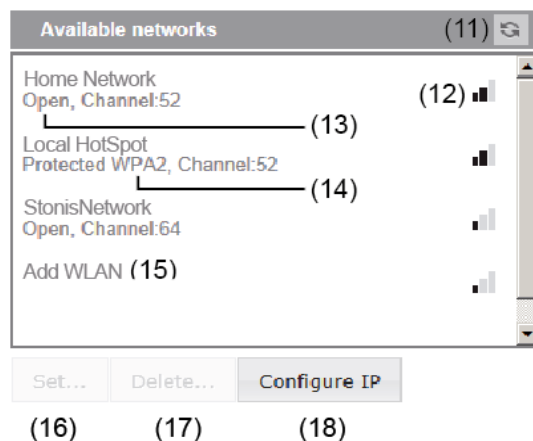

- (11) "Refresh" button
For starting a new search to find available WLAN networks
- (12) Signal quality indicator
One bar = weak signal
Three bars = strong signal
- (13) Network status
Open / Secure / Saved (once you have pressed the "Set..." button (16))
- (14) Encryption indicator
WPA / WPA2 / WEP
- (15) Add WLAN
For displaying hidden networks
As soon as you click this, the "WLAN Connection" window opens.

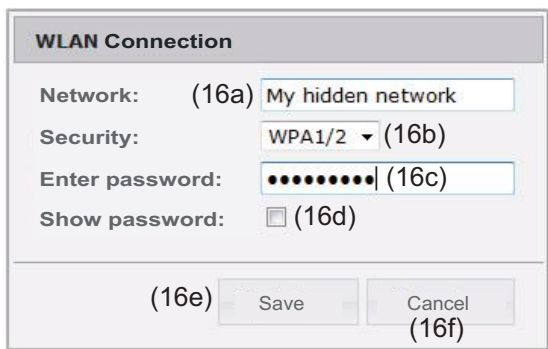

- (16a) Name of the hidden WLAN network
- (16b) Selection box for choosing the type of encryption for the hidden WLAN network
- (16c) Field for entering the password for the hidden WLAN network
- (16d) Selection box for specifying whether the password should be displayed
- (16e) "Save" button
- (16f) "Cancel" button
- (16) "Set..." button
For saving a selected WLAN network
Clicking the button opens the "WLAN Connection" window.

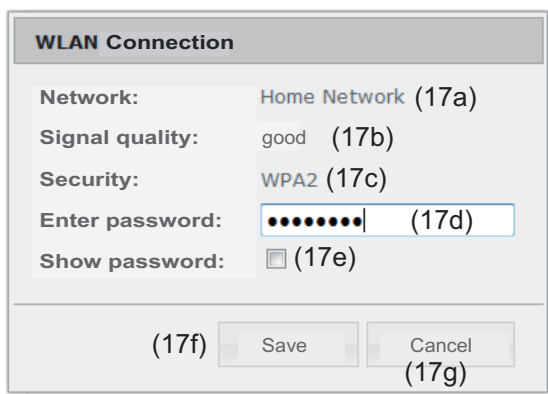

- (17a) Name of the selected WLAN network
- (17b) Signal strength of the selected WLAN network
- (17c) Encryption method used for the selected WLAN network
- (17d) Field for entering the password for the WLAN network
- (17e) Selection box for specifying whether the password should be displayed
- (17f) "Save" button
- (17g) "Cancel" button
- (17) "Delete..." button
For deleting a saved WLAN network
- (18) "Configure IP" button
Clicking this button opens the "Configure IP" window.

Local network via access point

WLAN Access Point Settings

(19) Network name: *

(20) Security key: *

(21) Show security key:

(19) Name of the WLAN access point

(20) Security key for the WLAN access point. This must contain at least eight characters.

(21) If this option is enabled, the security key (20) is displayed

Settings – Fronius Solar.web

Fronius Solar.web

You can use the Fronius Solar.web menu item to establish a direct connection between Fronius system monitoring and Fronius Solar.web.



Datalogging settings

Query cycle inverter (1)

[delete logged data ...](#)

(2)

Send real time data to Fronius Solar.web

No Yes

(3)

Send archive data to Fronius Solar.web

never daily hourly

(4)

(5)

(6)

[register at Solar.web ...](#)

(7)

Datalogging settings

- (1) Select the query cycle for the inverter:
Data can be queried every 5 / 10 / 15 / 20 / 30 minutes.
- (2) "delete logged data" button
When you click the "delete logged data" button, a confirmation prompts appears to check that you really do want to delete the logged data.
- (3) Here you can select whether archive data should be sent to Fronius Solar.web

Send archive data to Fronius Solar.web

- (4) never
- (5) daily
When you check this selection box, the associated settings are displayed:

never daily hourly

(6)

at (6a)

on Monday Tuesday Wednesday Thursday Friday Saturday Sunday

(6b)

- (6a) Field for entering the time (hour)
- (6b) Fields for selecting the days of the week

never daily hourly

(7)

- (7a) 00:00 01:00 02:00 03:00 04:00 05:00 06:00 07:00
 08:00 09:00 10:00 11:00 12:00 13:00 14:00 15:00
 16:00 17:00 18:00 19:00 20:00 21:00 22:00 23:00

- (7) hourly
When you check this selection box, the associated settings are displayed:
- (7a) Fields for selecting the time (hour)
- (8) "register at Solar.web" button
Clicking this button opens the Fronius Solar.web homepage and any data of relevance to Fronius Solar.web is sent automatically at the same time.
- (9) "Apply/Save" button
- (10) "Cancel/Discard entry" button

Settings – Service messages

General remarks Service messages or inverter errors are sent to Fronius system monitoring and saved. Use the “Service messages” option to define what method of external communication should be used for service messages. Communication can take place via:

- E-mail
- SMS

It is also possible to evaluate the service messages using Fronius Solar.web as well.

Service messages

Service messages

- (1) Activate “Meldung an E-Mail-Empfänger” [Send message to e-mail recipient] if you want service messages to be sent to one or more e-mail addresses.
- (2) Field for entering up to 10 e-mail addresses
If entering multiple e-mail addresses, use the “ ; ” character as a separator.
- (3) Selection box for specifying whether the service message should be sent by e-mail immediately or at a particular time
If you select “daily at”, the time (hour) option is displayed as well.
- (4) “Testmail schicken” [Send test e-mail] button
It can take several minutes to send a test e-mail.
- (5) Activate “Meldung an SMS-Empfänger” [Send message to SMS recipient] if you want service messages to be sent to a telephone number in the form of an SMS text message.
- (6) Field for entering the country prefix
For example: +43 = country prefix for Austria
- (7) Field for entering the local dialling code
- (8) Field for entering the telephone number
- (9) Field for daily sending
- (10) Box for selecting the time (hour) if service messages are to be sent via SMS

- (11) "Schaltfläche Test-SMS" [Send test SMS] button
It can take several minutes to send a test SMS.
- (12) Box for selecting the language in which the service message is to be sent
- (13) "Apply/Save" button
- (14) "Cancel/Discard entry" button

Settings – IO mapping

General

IO mapping



RS485

D+	+	+	0	2	4	6	8
D-	-	-	1	3	5	7	9

RS485

PIN ASSIGNMENTS

0. Grant emergency power locking
1. none
2. none
3. none
4. Emergency power request
5. Locking feedback
6. none
7. none
8. none
9. none

Emergency power ⊞

Grant emergency power locking Pin 0 (default) ▼

Locking feedback (optional) Pin 5 (default) ▼

Emergency power request Pin 4 (default) ▼

Load management ⊞

IO control ⊞

AUS - Demand Response Modes (DRM) ⊞

■ can be used as an input or output
 ■ can be used as an input
 pin already in use

This menu item allows you to configure the properties of the inverter's individual inputs and outputs (I/O). You can only select those settings that are supported by the system concerned (which are determined by the functionality of the system and how it has been configured).

An active output that has not been assigned (is "free") remains active until the inverter is restarted. The status of an output only changes in the event of new specifications for assigned services.

Emergency power	Function	Description	Default pin
	Grant emergency power locking	Output, triggers disconnection from the mains (protection)	0
	Feedback locking (optional)	Input, gives feedback on whether locking is active	5
	Emergency power request	Input, triggers emergency power mode	4

Emergency power mode is enabled by configuring these parameters.

Load management The pin for load management can be selected here. Additional load management settings are available in the "Load management" menu item.
Default pin: 1

IO control The pins for the IO control can be set here. Additional settings can be adjusted in the "PSC editor - IO control" menu.

IO control	Default pin	IO control	Default pin
IO control 1 (optional)	2	IO control 6 (optional)	7
IO control 2 (optional)	3	IO control 7 (optional)	8
IO control 3 (optional)	4	IO control 8 (optional)	9
IO control 4 (optional)	5	IO control feedback (optional)	0
IO control 5 (optional)	6		

AUS - Demand Response Modes (DRM)

Demand Response Modes for Australia

The pins for control via DRM can be set here:

IMPORTANT! To control the inverter via DRM, a Fronius DRM interface (item number 4,240,005) is required in the inverter. Installation is described in the Installation Instructions for the Fronius DRM interface. The Installation Instructions for the Fronius DRM interface are available on the Fronius homepage at the following link:



<http://www.fronius.com/QR-link/4204102292>

Mode	Description	Information	Default pin
DRM0	Inverter disconnects itself from the grid	Open grid relay	
		REF GEN	FDI
		COM LOAD	FDI
		or combinations of invalid DRM1 - DRM8	
DRM1	$-P_{nom} \leq 0\%$ without disconnection from the grid	limits effective power input	6
DRM2	$-P_{nom} \leq 50\%$	limits effective power input	7
DRM3	$-P_{nom} \leq 75\% \ \& \ +Q_{rel}^* \geq 0\%$	limits effective power input	8
		and sets the reactive power	
DRM4	$-P_{nom} \leq 100\%$	Normal operation without limitation	9
DRM5	$+P_{nom} \leq 0\%$ without disconnection from the grid	limits effective power output	6
DRM6	$+P_{nom} \leq 50\%$	limits effective power output	7

Mode	Description	Information	Default pin
DRM7	$+P_{nom} \leq 75\% \ \& \ -Q_{rel}^* \geq 0\%$	limits effective power output and sets the reactive power	8
DRM8	$+P_{nom} \leq 100\%$	Normal operation without limitation	9

FDI on the Fronius DRM interface

* The values for Q_{rel} can be set in the PSC Editor menu item.

The remote control capability of the inverter always relates to the nominal device output.



NOTE! If no DRM control (DRED) is connected to the Datamanager and the "AUS - Demand Response Mode (DRM)" function is activated, the inverter switches to standby mode.

Settings - load management

Load management

Load management

Output: Load management 1 State: ---

Controlling

deactivated
 by power production
 by power surplus (in case of feed-in limits)

Thresholds

on: W
off: W

Duration

Minimum duration per on-signal: Minutes
 Maximum duration per day: Minutes

Desired duration

Status

Control

- Control via Energy Manager deactivated.
- Control via Energy Manager is based on the power produced.
- Control via Energy Manager is based on surplus power (with feed-in limits). This option can only be selected if a meter has been connected. Control via Energy Manager is based on the amount of energy actually fed into the grid.

Thresholds

- on: For entering an effective power limit as of which output I/O 1 is to be activated
- off: For entering an effective power limit as of which output I/O 1 is to be deactivated

Duration

- Field for activating the minimum running time per switch-on operation
- Field for specifying the minimum amount of time that output I/O 1 should remain activated for per switch-on operation.
- Field for activating the maximum running time per day
- Field for specifying the maximum total amount of time that output I/O 1 should be activated for per day (allowing for several switch-on operations).

Desired duration

- Field for activating a desired running time

Settings – Push Service

Push Service

This function allows you to export current and log data to an external server in different formats or using different protocols.

Push Service

(1) (2)

+ Add (3)

▼ New FTP Service 0 (5) (4) State: ---

Name: New FTP Service 0

Data format: Demo Content by FTP upload (6)

Interval: 10 sec activated

Server:Port: MyServer:21 (7)

Upload file name: /anypath/anyfile{DATE}{TIME}.any (7)

Login:

Proxy

Server:Port: http://anyserver:8080 (8)

User: anyuser

Password: ●●●●●●●●

Delete (9)

- (1) "Apply/Save" button
- (2) "Cancel/Discard entry" button
- (3) "Add" button
Click this button to add a new push service job. The new job is saved by clicking the "Apply/Save" button (1).
- (4) State
Displays the current status of the respective push service job
- (5) Name displayed for the push service job
- (6) Area for entering general data:
Name (name of the push service job)
Data format
Protocol type (FTP upload/HTTP POST)
Interval
Activation status
- (7) Area for entering destination data:
Server port
Upload file name
Login (user/password)

- (8) Area for entering proxy data:
Server port
User
Password

 - (9) "Delete" button
Click this button to delete the selected push service job.
-

Further information about the push service function

For further information about the push service function, please see the following operating instructions:

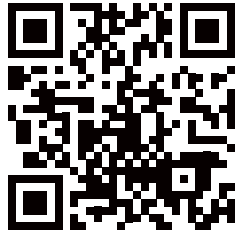

<http://www.fronius.com/QR-link/4204102152>

42,0410,2152
Fronius Push Service

Settings – Modbus

General remarks With a web browser, you can use the Fronius system monitoring web page to make settings for the Modbus connection that are not accessible via the Modbus protocol.

Further information about the Modbus function For further information about the Modbus function, please see the following Operating Instructions:

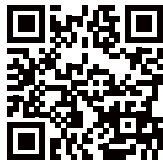

<http://www.fronius.com/QR-link/4204102049>

42,0410,2049
Fronius Datamanager Modbus TCP & RTU

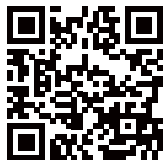

<http://www.fronius.com/QR-link/4204102108>

42,0410,2108
Fronius Datamanager Modbus RTU Quickstart Guide

Exporting data via Modbus

Modbus

Data export via Modbus (1) (2)
 off tcp



Controlling priority

IO control 1 2 3
 1 2 3
 Dynamic power reduction 1 2 3 (3)
 Controlling via Modbus 1 2 3

Notification: a change of control priorities is possible only in the dno editor with the service password.

Legend:

- 1 ... highest priority
- 2 ... medium priority
- 3 ... lowest priority

Data export via Modbus

Here you can activate the Modbus service and select the transmission protocol. If the Modbus service is activated, additional input fields are made available.

The Modbus RTU transmission protocol is only available with Fronius system monitoring.

- (1) **off**
No data exported via Modbus
- (2) **tcp**
Data exported via Modbus TCP

(2)

Data export via Modbus off tcp

Modbus port (2a)

String control address offset

Sunspec Model Type float int + SF

Demo mode (2b)

Inverter control via Modbus (2c)

Restrict the control

(2a) **Modbus port**

Number of the TCP port that is to be used for Modbus communication.

(2b) **Demo mode**

Demo mode is used to implement or validate a Modbus master. It enables inverter and Fronius string control data to be read out, even if no device is actually connected or active. The same data is always returned for all registers.

(2c) **Inverter control via Modbus**

If this option is activated, the inverters can be controlled via Modbus.

The "Restrict the control" selection box is displayed.

Inverter control includes the following functions:

- On/Off
- Power reduction
- Specification of a constant cos phi power factor
- Specification of a constant reactive power value

(3) **Control priorities**

The control priorities define which service takes priority during inverter control.

1 = highest priority, 3 = lowest priority

The control priorities can only be changed under the **PSC EDITOR** menu item.

(4) **"Apply/Save" button**

(5) **"Cancel/Discard entry" button**

Restricting control

The "Steuerung einschränken" [Restrict control] option is only available with TCP transmission protocols.

It prevents unauthorised persons from issuing inverter control commands by only allowing certain devices to perform control functions.

Inverter control via Modbus

Restrict the control (1)

IP address × (2)

- (1) **Steuerung einschränken [Restrict control]**
If this option is activated, only certain devices are allowed to send control commands.
- (2) **IP address**
If inverter control is to be limited to one or more devices, use this field to enter the IP addresses of the one(s) that is/are allowed to send commands to Fronius system monitoring. Use commas to separate multiple entries.

Examples:

- One IP address: **98.7.65.4**
 - Inverter may only be controlled by IP address *98.7.65.4*
- Multiple IP addresses: **98.7.65.4,222.44.33.1**
 - Inverter may only be controlled by IP addresses *98.7.65.4 and 222.44.33.1*
- IP address space could (for example) be specified as a range from 98.7.65.1 to 98.7.65.254 (CIDR notation) as follows: **98.7.65.0/24**
 - Inverter may only be controlled by IP addresses *98.7.65.1 to 98.7.65.254*

Saving or discarding changes



Saves the settings and displays a message to indicate that the save operation was successful

If you exit the “Modbus” menu item without saving, all the changes you have made will be discarded.



Triggers a confirmation prompt to check that you really do want to discard the changes that have been made and then restores the last set of saved values.

Settings – Energy Manager

General

The Fronius hybrid inverter always controls the system by adjusting it in line with the target value set at the metering point. In "Automatic" operating mode (factory setting), the system is adjusted so that 0 W is achieved at the feed-in point (maximum self-consumption).

The target value still applies even if another source feeds energy in at this metering point. However, in this case:

- The Fronius Smart Meter must be installed at the feed-in point
- The option that allows the battery to be charged by another producer must be activated (see Battery management section on page 108).



Own consumption optimisation:

Own consumption optimisation: automatic manual
Target values at the metering point: W

Emergency power

 Operating mode:
Remaining battery capacity: % Soc
SoC-warning level: % Soc

Own consumption optimisation

Option for selecting automatic or manual self-consumption optimisation

Target value at the metering point

If you opt for "manual" under "Own consumption optimisation", you can select the target value at the metering point and choose between "Bezug" [Consume] and "Feed-in" here.

Operating mode

"Automatic" or "Off" can be selected for emergency power mode.

The emergency power functionality can only be activated once the required IO assignments have been configured for emergency power. The meter must be installed at the feed-in point and configured.

Remaining battery capacity

If emergency power mode is set to "Auto", during grid-connected operation energy is drawn from the battery until the battery capacity specified here is reached.

SOC warning level

A warning is output when the residual capacity of the battery specified here is reached in emergency power mode

Energy Manager examples

These examples illustrate possible energy flows. Efficiency values have not been taken into account.

Example involving Fronius Energy Package

PV system connected to Fronius Symo Hybrid:	1000 W
Household consumption:	500 W
Target value set at feed-in point:	0 W

Energy fed into Fronius Solar Battery:	500 W
Power output (AC) by inverter:	500 W
Energy fed into the public grid:	0 W

Example involving Fronius Energy Package plus a second producer within the home

PV system connected to Fronius Symo Hybrid:	1000 W
Second producer on home network:	2000 W
Household consumption:	500 W
Target value set at feed-in point:	0 W

Energy fed into Fronius Solar Battery:	2500 W
Power consumed (AC) by inverter:	1500 W
Energy fed into the public grid:	0 W

Example involving Fronius Energy Package without photovoltaics but with a second producer within the home

Second producer on home network:	2000 W
Household consumption:	500 W
Target value set at feed-in point:	0 W

Energy fed into Fronius Solar Battery:	1500 W
Power consumed (AC) by inverter:	1500 W
Energy fed into the public grid:	0 W

Example involving Fronius Energy Package plus a second producer within the home (with AC max. limiting)

PV system connected to Fronius Symo Hybrid:	1000 W
Second producer on home network:	2000 W
Household consumption:	500 W
Target value set at feed-in point:	0 W
Max. AC power consumption limited to:	1000 W

Energy fed into Fronius Solar Battery:	2000 W
Power consumed (AC) by inverter:	1000 W
Energy fed into the public grid:	500 W

Battery management



reserve battery capacity

battery charge from producers in the home network



battery charge from producers in the home network

deactivated ▾

Calibration charge

The Fronius Energy Package will periodically run an automatic full charge of the Fronius Solar Battery to calibrate all components. This process can be started manually here.

[start calibration charge](#)



reserve battery capacity:

This function is required to prevent available energy from going to waste if the photovoltaic system is overdimensioned or in the case of dynamic power reduction. Up until a certain time of day, energy is only fed into the Fronius Solar Battery if dynamic power reduction is active or if the amount of PV power available on the Fronius hybrid inverter exceeds what can be delivered on the AC side (overdimensioning) - see example below.

Consequently, storage space is "reserved" in the Fronius Solar Battery to accommodate this operating scenario. Standard energy management (self-consumption optimisation) only resumes once the set time is reached.

battery charge from producers in the home network:

If further decentralised producers are installed in the household and are integrated into the self-consumption rule for the Fronius hybrid inverter, you must activate this setting. This means that energy can be drawn from the household network and fed into the Fronius Solar Battery for charging purposes via the Fronius hybrid inverter.

You can restrict how much power is consumed by the Fronius hybrid inverter by specifying the maximum AC power. The maximum power consumption is limited to the AC nominal output of the Fronius hybrid inverter.

To ensure smooth operation in conjunction with other energy producers, it is important to install the Fronius Smart Meter at the feed-in point. The Fronius hybrid inverter and other energy producers must be connected to the public grid via the Fronius Smart Meter.

Calibration charge:

At regular intervals, the Fronius hybrid inverter automatically charges the Fronius Solar Battery until it is full for the purpose of calibrating all the components. This process can be started manually here.

IMPORTANT! When calibration charging is activated, normal operation is interrupted and the system may draw energy from the PSC grid. The process can take several hours and cannot be aborted.

Once calibration is complete, the system automatically reverts to the operating mode that was set originally.

This calibration charging process is also performed automatically during actual operation after a number of charging and discharging cycles.

If the "permit battery charging from PSC grid" setting is deactivated, this calibration charging process relies exclusively on energy from the photovoltaic system. Depending on the insolation conditions and size of the systems concerned, the charging process can take a very long time.

If the "permit battery charging from PSC grid" setting is activated, the calibration charging process is performed by drawing a constant current from the photovoltaic system and PSC grid.

Example of reserve battery capacity

Example 1 - dynamic power regulation is active:

Actual state:

- Symo Hybrid 5.0-3-S
- PV output = 5 kWp
- Max. grid power feed 60% (3 kW)
- Fronius Solar Battery 6.0
- Reserve battery capacity: unrestricted charge from 14:00

System behaviour at 11:00 (5 kW PV output):

- Household network consumption = 1 kW
- Grid power feed = 3 kW
- Battery charge = 1 kW

System behaviour at 15:00 (5 kW PV output):

- Household network consumption = 1 kW
- Grid power feed = 0.8 kW
- Battery charge = 3.2 kW (nominal charging power for the Fronius Solar Battery 6.0)

Example 2 - more PV power is available on the Fronius Symo Hybrid than can be released on the AC side (= overdimensioning)

Actual state:

- Symo Hybrid 5.0-3-S
- PV output = 8 kWp
- Fronius Solar Battery 6.0
- Reserve battery capacity: unrestricted charge from 14:00

System behaviour at 11:00 (7 kW PV output):

- Household network consumption = 1 kW
- Grid power feed = 5 kW
- Battery charge = 1 kW

System behaviour at 15:00 (7 kW PV output):

- Household network consumption = 1 kW
- Grid power feed = 2.8 kW
- Battery charge = 3.2 kW (nominal charging power for the Fronius Solar Battery 6.0)

Settings – System overview

System overview

System overview

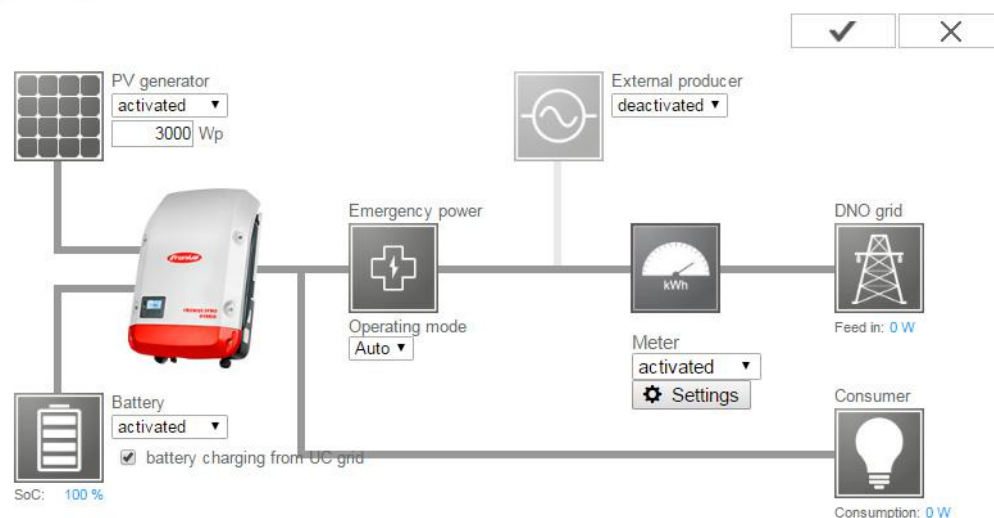

PV generator:

If there is no solar module connected to the Fronius hybrid inverter, the PV power option must be deactivated. The connected PV power must be entered in the field underneath.

Battery:

If a battery is connected to the Fronius hybrid inverter, it must be activated here. This setting can only be made when there is an active connection to a battery. If you are unable to make this setting, check whether the battery is switched on and whether the data connection has actually been established. If there is a connection, the current state of charge of the battery will be indicated underneath the battery symbol.

Battery charging from DNO grid:

If you want the battery to be charged from the public grid, you can activate this here. Depending on what is required by standards or the feed-in tariff rules, it may be necessary to deactivate the setting. This setting does not affect the charging of the battery by other producers within the home. It merely relates to the process of drawing charging energy from the public grid. Regardless of this setting, the battery will still be charged from the public grid if needed for service reasons (e.g. to protect against deep discharge).

Emergency power:

Emergency power mode can be activated or deactivated here. The emergency power functionality can only be activated once the required IO assignments have been configured for emergency power. The meter must be installed at the feed-in point and configured.

External producer:

If further decentralised producers are installed in the household and have been integrated into the self-consumption rule for the Fronius hybrid inverter, you must activate this setting. This means that energy can be drawn from the household network and fed into the battery via the Fronius hybrid inverter.

You can restrict how much power is consumed by the Fronius hybrid inverter by specifying a maximum AC power value (AC max.). The maximum power consumption is limited to the AC nominal output of the Fronius hybrid inverter.

Meter:

To ensure smooth operation in conjunction with other energy producers and in emergency power mode, it is important to install the Fronius Smart Meter at the feed-in point. The Fronius hybrid inverter and other producers must be connected to the public grid via the Fronius Smart Meter.

This setting also affects how the Fronius hybrid inverter behaves overnight. If the function is deactivated, the inverter switches to Standby mode as soon as there is no more PV power available, provided that no energy management command is sent to the battery (e.g. minimum state of charge reached). The message "Power low" is displayed. The inverter restarts as soon as an energy management command is sent or there is sufficient PV power available.

If the function is activated, the inverter remains permanently connected to the grid so that energy can be drawn from other producers at any time.

The meter is automatically detected after it has been connected. The location of the meter and, if required, the meter converter ratio can be configured under Settings.

Fronius Smart Meter

Recording self-consumption via a Fronius Smart Meter

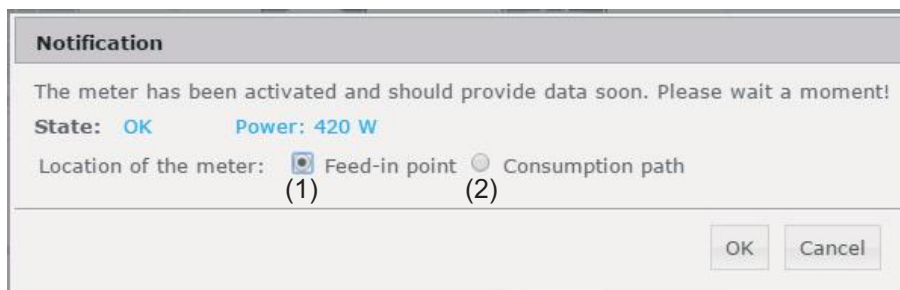

- (1) Meter positioned at feed-in point
The meter measures the amount of power and energy fed in. Consumption is determined on the basis of these values and the system data.
- (2) Meter positioned at consumption branch
The meter directly measures the amount of power and energy consumed. These values and the system data are used to determine the amount of power and energy fed in.

How to connect the Fronius Smart Meter to Fronius system monitoring:

Fronius Smart Meter 63A

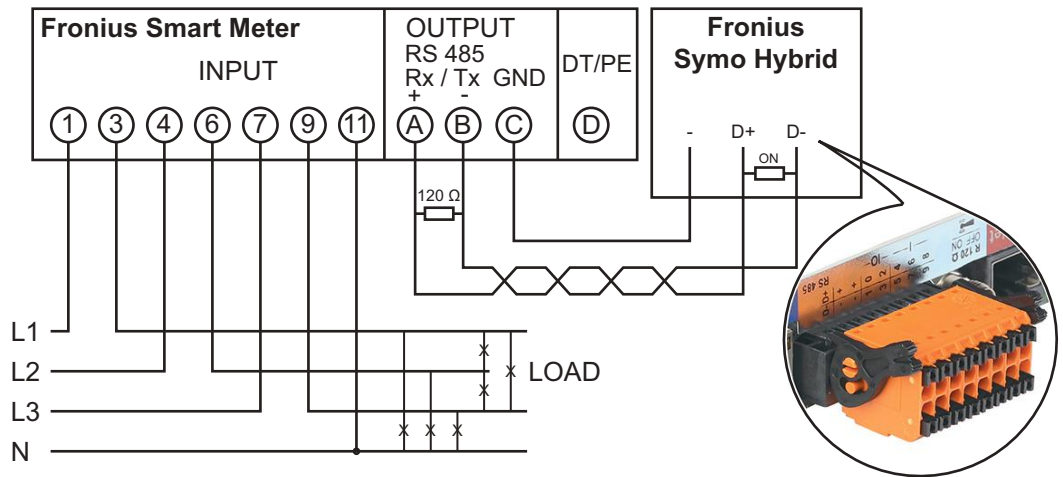

Fronius Smart Meter 50kA-3

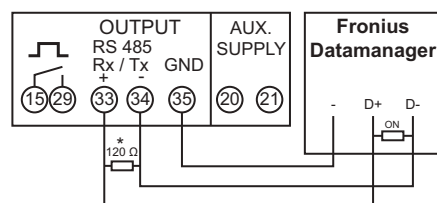
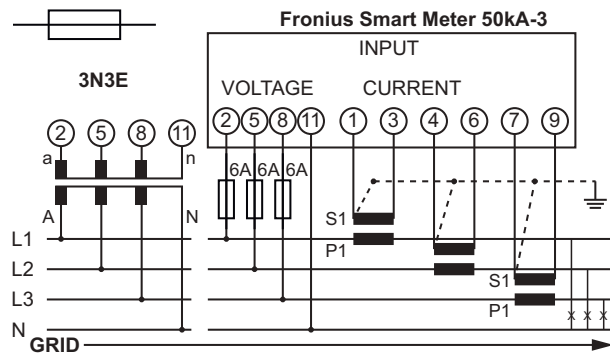
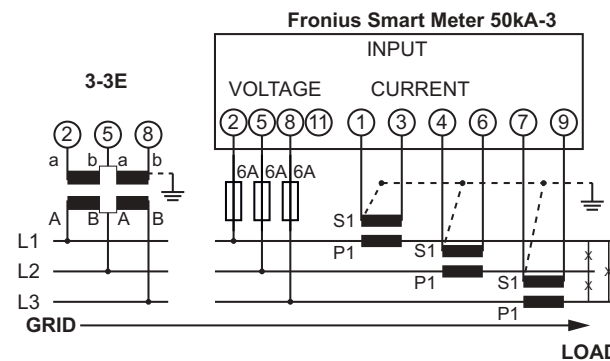
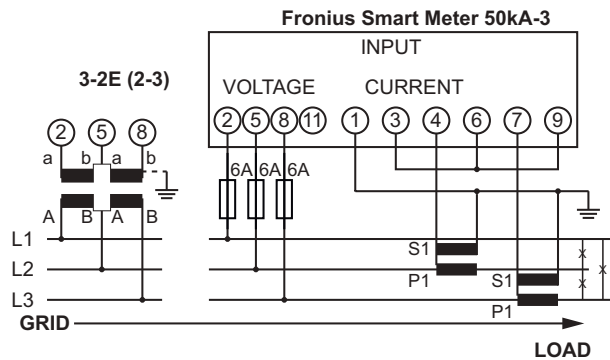
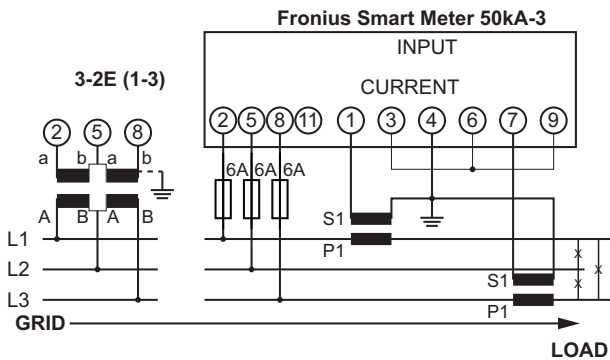
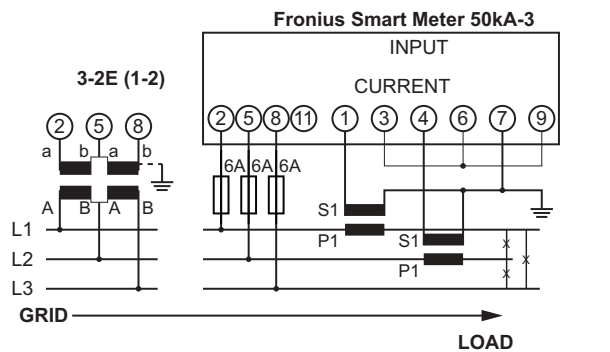
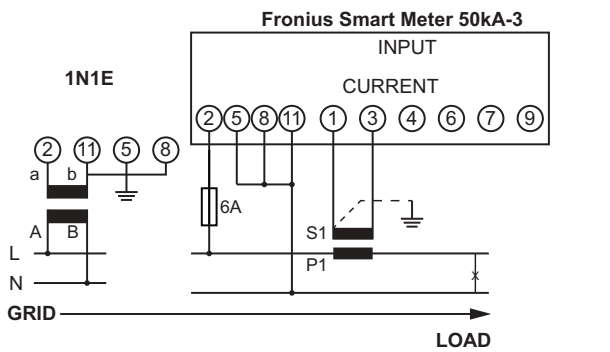

Settings – EVU Editor

General remarks Use the “EVU Editor” menu item to make the settings that are of relevance to a utility company. You can set an effective power limit in % and/or a power factor limit.

IMPORTANT! Settings under the “EVU Editor” menu item are only to be made by trained and qualified personnel!

The service password must be entered in order to access the “EVU Editor” menu item.

PSC Editor – IO control

UC editor

My System, at Mittwoch, 26. März 2014, 08:47:45

(11) ✓ (12) ✕

(1)	(2)			(5)	(6)	(7)
IO control	Input pattern	Active power	Power factor cosφ	UC output	excluded inverter(s)	
unlocked	I1 I2 I3 I4 I5 I6 I7 I8			I/O 0		
<input checked="" type="checkbox"/>	<input checked="" type="checkbox"/> <input type="checkbox"/> <input type="checkbox"/> <input type="checkbox"/> <input type="checkbox"/> <input type="checkbox"/> <input type="checkbox"/> <input type="checkbox"/> <input type="checkbox"/>	<input checked="" type="checkbox"/> 100 %	<input type="checkbox"/> 1 <input type="radio"/> ind <input type="radio"/> cap	<input checked="" type="checkbox"/>	<input type="text"/>	<input type="button" value="−"/>
<input checked="" type="checkbox"/>	<input type="checkbox"/> <input checked="" type="checkbox"/> <input type="checkbox"/> <input type="checkbox"/> <input type="checkbox"/> <input type="checkbox"/> <input type="checkbox"/> <input type="checkbox"/> <input type="checkbox"/>	<input checked="" type="checkbox"/> 60 %	<input type="checkbox"/> 1 <input type="radio"/> ind <input type="radio"/> cap	<input checked="" type="checkbox"/>	<input type="text"/>	<input type="button" value="−"/>
<input checked="" type="checkbox"/>	<input type="checkbox"/> <input type="checkbox"/> <input checked="" type="checkbox"/> <input type="checkbox"/> <input type="checkbox"/> <input type="checkbox"/> <input type="checkbox"/> <input type="checkbox"/> <input type="checkbox"/>	<input checked="" type="checkbox"/> 30 %	<input type="checkbox"/> 1 <input type="radio"/> ind <input type="radio"/> cap	<input checked="" type="checkbox"/>	<input type="text"/>	<input type="button" value="−"/>
<input checked="" type="checkbox"/>	<input type="checkbox"/> <input type="checkbox"/> <input type="checkbox"/> <input checked="" type="checkbox"/> <input type="checkbox"/> <input type="checkbox"/> <input type="checkbox"/> <input type="checkbox"/> <input type="checkbox"/>	<input checked="" type="checkbox"/> 0 %	<input type="checkbox"/> 1 <input type="radio"/> ind <input type="radio"/> cap	<input checked="" type="checkbox"/>	<input type="text"/>	<input type="button" value="−"/>
<input type="checkbox"/>	<input type="checkbox"/> <input type="checkbox"/> <input type="checkbox"/> <input type="checkbox"/> <input type="checkbox"/> <input type="checkbox"/> <input type="checkbox"/> <input type="checkbox"/> <input type="checkbox"/>	<input type="checkbox"/> %	<input type="checkbox"/> <input type="radio"/> ind <input type="radio"/> cap	<input type="checkbox"/>	<input type="text"/>	<input type="button" value="+"/>

... not applicable
 ... not considered
 ... pin open
 ... pin closed

PSC Editor – The factory settings for effective power are 100%, 60%, 30% and 0%. The settings can be changed at any time.

- (1) Rule activation
- (2) Input pattern (assignment of individual I/Os)
 - 1 x click = white
 - 2 x click = blue
 - 3 x click = grey

The virtual IO mapping is displayed in accordance with chapter "Settings – IO mapping" (see page 97). The display may vary in older versions of the software.

- (3) Effective power
 - Activate it first and then enter the required effective power value in %.

- (4) cos phi power factor
Activate it first, enter the required power factor and then complete the process by selecting "ind" or "cap".

ind = inductive
cap = capacitive.
- (5) PSC output (feedback output)
When the rule is enabled, output I/O 0 is activated (e.g. for operating a signalling device).
- (6) excluded inverters
Enter the numbers of the inverters that are to be excluded from the rule. If entering multiple inverters, use commas to separate them.
- (7) Deleting/adding a rule
+ = add a new rule
- = delete the currently selected rule
- (8) Key to colours
- (9) "Import" button
Click this to import rules in *.fpc format.

The "Import" button only works with certain browsers, e.g. it is supported by Firefox and Google Chrome.
- (10) "Export" button
Click this to save the rules separately in *.fpc format.
- (11) "Apply/Save" button
- (12) "Cancel/Discard entry" button



NOTE! You can use the web browser's print function to create a PDF record of the settings that you have made under the "PSC Editor" menu item or to print these settings out (e.g. in the form of a commissioning record).

Connection example

- (1) Ripple control signal receiver with 3 relays, for effective power limiting
- (2) Ripple control signal receiver with 3 relays, for power factor limiting
- (3) Fronius system monitoring I/Os
- (4) Consumers (e.g. signal lamp, signal relay)

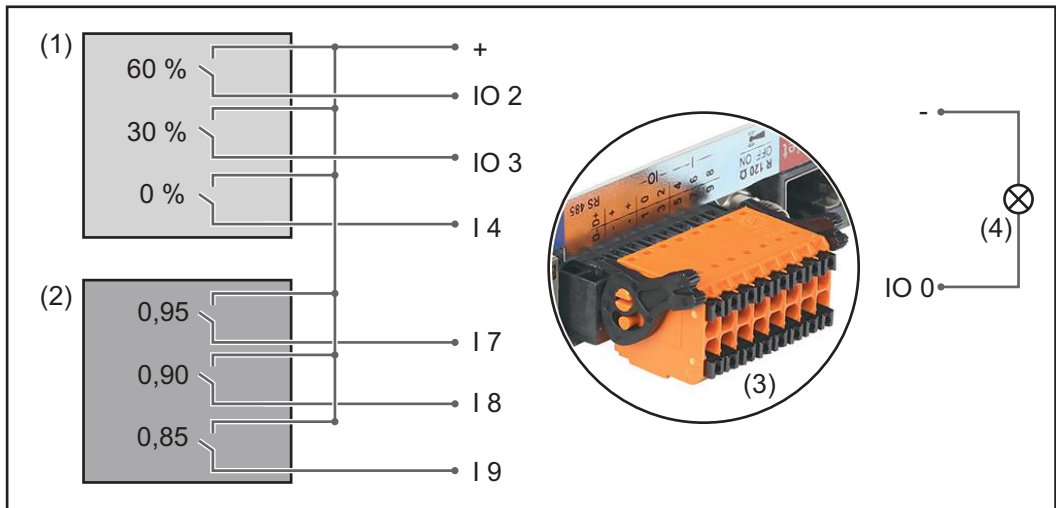

The ripple control signal receiver and the Fronius system monitoring connector are connected to one another by means of a four-pin cable in accordance with the connection diagram. If the distance between the Fronius system monitoring datalogger and the ripple control signal receiver exceeds 10 m, a shielded cable is recommended.

EVU Editor settings:

Approved	Input pattern	Effective power	Power factor $\cos\phi$	PSC output	excluded inverters
	* 1 2 3 4 5 6 7 8				
(1) ↑	<input checked="" type="checkbox"/> 1 <input type="checkbox"/> 2 <input type="checkbox"/> 3 <input type="checkbox"/> 4 <input type="checkbox"/> 5 <input type="checkbox"/> 6 <input type="checkbox"/> 7 <input type="checkbox"/> 8	<input checked="" type="checkbox"/> 60 %	<input type="checkbox"/> 1 <input type="radio"/> ind <input checked="" type="radio"/> cap	<input checked="" type="checkbox"/>	<input type="text"/>
↓	<input type="checkbox"/> 1 <input checked="" type="checkbox"/> 2 <input type="checkbox"/> 3 <input type="checkbox"/> 4 <input type="checkbox"/> 5 <input type="checkbox"/> 6 <input type="checkbox"/> 7 <input type="checkbox"/> 8	<input checked="" type="checkbox"/> 30 %	<input type="checkbox"/> 1 <input type="radio"/> ind <input checked="" type="radio"/> cap	<input checked="" type="checkbox"/>	<input type="text"/>
↑	<input type="checkbox"/> 1 <input type="checkbox"/> 2 <input checked="" type="checkbox"/> 3 <input type="checkbox"/> 4 <input type="checkbox"/> 5 <input type="checkbox"/> 6 <input type="checkbox"/> 7 <input type="checkbox"/> 8	<input checked="" type="checkbox"/> 0 %	<input type="checkbox"/> 1 <input type="radio"/> ind <input checked="" type="radio"/> cap	<input checked="" type="checkbox"/>	<input type="text"/>
(2) ↓	<input type="checkbox"/> 1 <input type="checkbox"/> 2 <input type="checkbox"/> 3 <input checked="" type="checkbox"/> 4 <input type="checkbox"/> 5 <input type="checkbox"/> 6 <input type="checkbox"/> 7 <input type="checkbox"/> 8	<input type="checkbox"/> 100 %	<input checked="" type="checkbox"/> 0,95 <input type="radio"/> ind <input checked="" type="radio"/> cap	<input checked="" type="checkbox"/>	<input type="text"/>
↑	<input type="checkbox"/> 1 <input type="checkbox"/> 2 <input type="checkbox"/> 3 <input type="checkbox"/> 4 <input checked="" type="checkbox"/> 5 <input type="checkbox"/> 6 <input type="checkbox"/> 7 <input type="checkbox"/> 8	<input type="checkbox"/> 100 %	<input checked="" type="checkbox"/> 0,90 <input type="radio"/> ind <input checked="" type="radio"/> cap	<input checked="" type="checkbox"/>	<input type="text"/>
↓	<input type="checkbox"/> 1 <input type="checkbox"/> 2 <input type="checkbox"/> 3 <input type="checkbox"/> 4 <input type="checkbox"/> 5 <input checked="" type="checkbox"/> 6 <input type="checkbox"/> 7 <input type="checkbox"/> 8	<input type="checkbox"/> 100 %	<input checked="" type="checkbox"/> 0,85 <input type="radio"/> ind <input checked="" type="radio"/> cap	<input checked="" type="checkbox"/>	<input type="text"/>
	<input type="checkbox"/> 1 <input type="checkbox"/> 2 <input type="checkbox"/> 3 <input type="checkbox"/> 4 <input type="checkbox"/> 5 <input type="checkbox"/> 6 <input type="checkbox"/> 7 <input type="checkbox"/> 8	<input type="checkbox"/> %	<input type="checkbox"/> <input type="radio"/> ind <input checked="" type="radio"/> cap	<input checked="" type="checkbox"/>	<input type="text"/>

... not usable
 ... not considered
 ... contact open
 ... contact closed

"PSC editor - AUS - Demand Response Modes (DRM)" A value for the apparent power consumption and apparent power output can be entered here for the Australia country setup.

EVU Editor – Dynamic power reduction Utility companies or grid operators may stipulate feed-in limitations for an inverter (e.g. max. 70% of kWp or max. 5 kW). Dynamic power reduction takes account of self-consumption by the household before the power of an inverter is reduced:

- A custom limit can be set.
- A Fronius Smart Meter can be connected to the D- / D+ connection sockets for Modbus data on the system monitoring datalogger.

With the Fronius Symo Hybrid, any PV power that is not allowed to be fed into the grid is used to charge the Fronius Solar Battery instead so that it does not go to waste. Dynamic power reduction is only activated if the battery is full or cannot be charged for some other reason.



Dynamic power reduction

(1) (2)
 Power limit: No limit limit for entire system
 total DC power of the system: Wp (3)
 max. production power of entire system: (4) (5)

Leistungslimit [Power limit]

This allows you to define the maximum output power of the photovoltaic system.

- (1) No limit
The photovoltaic system converts all the available PV energy.
- (2) Dynamic power reduction limit for entire system
The entire photovoltaic system is limited in accordance with a set power limit.
- (3) Field for entering the total DC system power in Wp
This value serves as a reference for the rule and also for failures (e.g. a meter failure).
- (4) Field for entering the max. power in W or %

If no meter has been selected under the “Meter” menu item:
Max. power produced by the entire system

If “Fronius Smart Meter” has been selected under the “Meter” menu item:
Max. grid power feed
- (5) Box for selecting % or W
- (6) “Apply/Save” button
- (7) “Cancel/Discard entry” button

Example: Dynamic power reduction

(efficiency values have not been taken into account)

PV system connected to Fronius Symo Hybrid:	5000 W
Household consumption:	1000 W
Max. grid power feed:	60% = 3000 W
Power at grid feed-in point:	3000 W
Power at inverter output:	4000 W
Energy fed into Fronius Solar Battery:	1000 W

In this example, no more than 3000 W may be fed into the grid at the grid feed-in point. However, any loads that are located between the inverter and the grid feed-in point can be supplied by additional power from the inverter. These loads are also compensated as required.

EVU Editor – Control priorities



Controlling priority

	1	2	3	
Ripple control signal receiver	<input checked="" type="radio"/>	<input type="radio"/>	<input type="radio"/>	(1)
Dynamic power reduction	<input type="radio"/>	<input checked="" type="radio"/>	<input type="radio"/>	(2)
Controlling via Modbus	<input type="radio"/>	<input type="radio"/>	<input checked="" type="radio"/>	(3)

1 = highest priority, 3 = lowest priority

- (1) For setting the control priorities for the ripple control signal receiver
- (2) For setting the control priorities for dynamic power reduction
- (3) For setting the control priorities for control via Modbus
- (4) “Apply/Save” button
- (5) “Cancel/Discard entry” button

EVU Editor – Batterie Ladung [Battery charging]

If you want the Fronius Solar Battery to be charged from the public grid, you can activate this here. Depending on what is required by standards or the feed-in tariff rules, it may be necessary to deactivate the setting.

This setting does not affect the charging of the Fronius Solar Battery by other producers within the home. It merely relates to the process of drawing charging energy from the public grid.

Regardless of this setting, any charging from the public grid that is required for service reasons (e.g. to protect against deep discharge) is still performed.

Dynamic power regulation with several inverters

Example 1

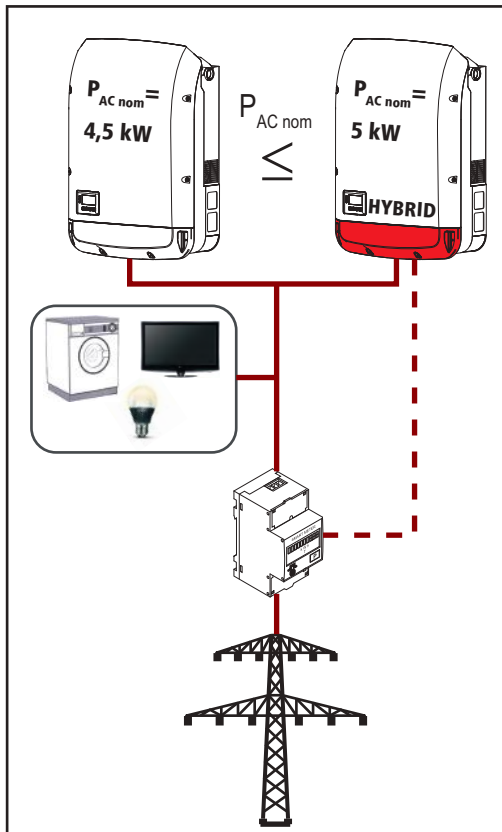

$$P_{AC\ nom} (\text{inverter 1}) \leq P_{AC\ nom} (\text{hybrid})$$

Example: 4.5 kW < 5 kW

A Smart Meter is only required for the hybrid inverter. This must be installed at the feed-in point.

Hybrid system overview (web page):

Settings – System overview: Meter must be configured at the feed-in point

Settings – PSC editor:
Dynamic power reduction
Power limit: Limit for the entire system
Total DC system output: 9500 Wp
Max. grid power feed: 60%

Example 2

If there are two Smart Meters in the feed-in branch, the Datamanager and the Fronius Datamanager (hybrid) in Solar.web cannot be shown combined in one PV system. Two individual PV systems must be created.

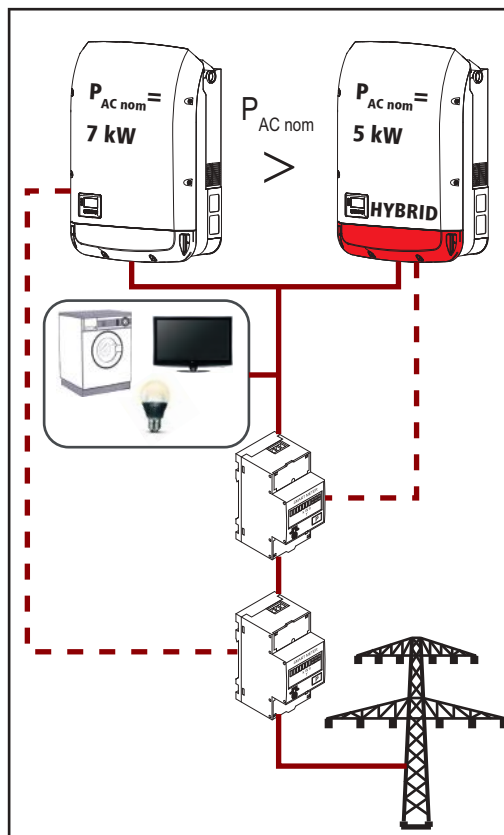

$P_{AC\ nom} (\text{inverter } 1) > P_{AC\ nom} (\text{hybrid})$

Example: 7 kW > 5 kW

Two Smart Meters are required for the inverters. These must be installed at the feed-in point.

Hybrid system overview (web page):

Settings – System overview: Meter must be configured at the feed-in point

Datamanager overview (web page):

Settings – System overview: Meter must be configured at the feed-in point

Settings – PSC editor:
Dynamic power reduction
Power limit: Limit for the entire system
Total DC system output: 12,000 Wp
Max. grid power feed: 60%

Settings – Battery

Battery

Advanced battery settings



Maximum SOC in operation % (1)
Minimum SOC in operation % (2)
Maximum charging current A (3)
Maximum discharge current A (4)



Service: Battery module replacement (5)

Start Service mode

- (1) **Maximum SOC in operation:**
Maximum state of charge (SOC) of the Fronius Solar Battery that is not to be exceeded during normal operation.
Once the set value has been reached, the Fronius hybrid inverter stops feeding energy into the Fronius Solar Battery.
Regardless of this setting, the Fronius hybrid inverter still performs an automatic process at regular intervals, which charges the Fronius Solar Battery up fully (100% SOC) for the purpose of calibrating all the components.
- (2) **Minimum SOC in operation:**
Minimum state of charge (SOC) of the Fronius Solar Battery that is not to be undershot during normal operation.
Once the set value has been reached, the Fronius hybrid inverter stops drawing energy from the Fronius Solar Battery.
This state of charge may be temporarily undershot as a result of battery self-discharge.
- (3) **Maximum charging current:**
Maximum charging current of the Fronius Solar Battery.
- (4) **Maximum discharge current:**
Maximum discharge current of the Fronius Solar Battery.
- (5) **Service: Battery module replacement**
Service mode allows you to replace and extend the battery modules and is also intended for test purposes.
When this mode is activated, the Fronius Solar Battery is charged or discharged by means of a 10 A current or with the maximum inverter power, regardless of any other parameter settings. The charging or discharging process continues until the state of charge stands at 53% (the SOC of new battery modules on delivery). The process can be aborted at any time.
Once this SOC has been reached, the system maintains it until Service mode is deactivated again.

Troubleshooting and maintenance

Fronius Symo Hybrid

Displaying status codes The inverter performs a system self diagnosis that automatically detects many faults that may occur and shows them on the display. This means you are promptly made aware of malfunctions in the inverter and the photovoltaic system, or of any installation or operating faults.

If the system self diagnosis has detected a specific fault, the associated status code will be shown on the display.

IMPORTANT! Status codes may sometimes appear briefly as a result of the inverter's control response. If the inverter then continues working with no sign of any problem, this means that there was no fault.

Total failure of the display The display can be supplied with power in three different ways. The display will only remain dark if all three methods fail. In this case:

- Check the AC voltage on the inverter connection sockets:
The AC voltage must be 220/230 V (+10% / -5%) or 380/400 V (+10% / -5%).
- Check the DC voltage of the solar modules on the connection sockets of the inverter:
The DC voltage must exceed 180 V.
- Check the DC voltage of the battery on the connection sockets of the inverter: The DC voltage must exceed 120 V.

Status codes – Class 1 Class 1 status codes generally only arise momentarily and are caused by the public grid.

Example: The grid frequency is too high and the inverter may not feed any energy into the grid owing to a standard. There is nothing wrong with the device.

The initial response of the inverter is to disconnect itself from the grid. The grid is subsequently checked during the stipulated monitoring period. If no further problem has been detected by the end of this period, then the inverter will resume feeding energy into the grid.

The GPIS SoftStart function is activated according to the country setup:

After cutting out due to an AC error, the output power of the inverter is continuously increased in line with the national guidelines.

Code	Description	Behaviour	Remedy
102	AC voltage too high		
103	AC voltage too low		
105	AC frequency too high	Following careful testing and when the grid conditions are within the permissible range again, the inverter will resume feeding energy into the grid.	Check grid connections; if this status code keeps recurring, contact your system fitter
106	AC frequency too low		
107	No AC grid		
108	Stand-alone operation detected		
112	RCMU error		
143	Emergency power overload	Emergency power mode is interrupted. The inverter attempts to start emergency power mode three times; if this is unsuccessful status code 145 is displayed	Check emergency power circuit; if this status code keeps recurring, contact your system fitter
144	Emergency power short-circuit		
145	Status code 143 or 144 has occurred more than three times		

**Status codes –
Class 3**

Class 3 includes status codes that may occur while feeding energy into the grid, but generally do not cause the process to be interrupted for any length of time.

The inverter disconnects automatically from the grid, the grid is then monitored as specified and the inverter attempts to resume feeding energy into the grid.

Code	Description	Behaviour	Remedy
301	Overcurrent (AC)	Short-term interruption while feeding energy into the grid. The inverter repeats its start-up routine.	*)
302	Overcurrent (DC) or battery not detected		
303	DC module overtemperature (PV)	Short-term interruption while feeding energy into the grid. The inverter repeats its startup routine.	Purge cooling air openings and heat sink; **)
304	AC module overtemperature		
305	No power being fed in, despite closed relays	Short-term interruption while feeding energy into the grid. The inverter repeats its startup routine.	**)
306	There is not enough PV power available for feeding energy into the grid and no power has been requested from the battery.	Short-term interruption while feeding energy into the grid. The inverter repeats its startup routine.	Wait for sufficient insolation; wait for an energy management command; **)
307	DC low DC input voltage too low for feeding energy into the grid	Short-term interruption while feeding energy into the grid. The inverter repeats its startup routine.	Wait for sufficient insolation; **)
IMPORTANT! Due to the low level of insolation early in the morning and in the evening, the status codes 306 (Power low) and 307 (DC low) are displayed routinely at these times of day. These status codes do not indicate any kind of fault.			
308	Intermediate circuit voltage too high	Short-term interruption while feeding energy into the grid. The inverter repeats its startup routine.	**)
309	PV input voltage too high		
313	Battery input voltage too high.	Short-term interruption while feeding energy into the grid. The inverter repeats its startup routine. This service code may occur sporadically even though there is no actual fault.	Switch on, connect or check battery; *)
314, 315	Internal system error	Short-term interruption while feeding energy into the grid. The inverter repeats its startup routine.	*)
318	Solar module return current detected		
324	DC module overtemperature (battery)	Short-term interruption while feeding energy into the grid. The inverter repeats its startup routine.	Purge cooling air openings and heat sink; **)

*) If the status code is displayed all the time: Notify a Fronius-trained service technician.

***) Fault is rectified automatically. If this status code keeps recurring, contact your system fitter

**Status codes –
Class 4**

Some of the class 4 status codes necessitate intervention by a Fronius-trained service engineer.

Code	Description	Behaviour	Remedy
401	Unable to communicate with the power stage set	The inverter will automatically attempt to connect again and, if possible, will resume feeding energy into the grid.	*)
406	DC module temperature sensor faulty (PV)		
407	AC module temperature sensor faulty		
408	DC component measured in the grid too high		
412	Fixed voltage mode has been selected instead of MPP voltage mode, and the fixed voltage has been set to too low or too high a value.	-	**)
415	Safety cut-out via option card or RECER-BO has triggered	The inverter is not feeding any energy into the grid.	*)
416	No communication possible between power stage set and control system.	The inverter will automatically attempt to connect again and, if possible, will resume feeding energy into the grid.	*)
417	Hardware ID problem	The inverter will automatically attempt to connect again and, if possible, will resume feeding energy into the grid.	Update inverter firmware; *)
420	Unable to communicate with system monitoring		
425	Unable to communicate with the power stage set		
426 - 427	Possible hardware fault		
431, 432	Software problem	The inverter is not feeding any energy into the grid.	Perform AC reset (switch automatic circuit breaker off and on again); update inverter firmware; *)
436	Functional incompatibility (one or more PC boards in the inverter are not compatible with each other, e.g. after a PC board has been replaced)	The inverter will automatically attempt to connect again and, if possible, will resume feeding energy into the grid.	Update inverter firmware; *)
437	Power stage set problem	The inverter will automatically attempt to connect again and, if possible, will resume feeding energy into the grid.	Update inverter firmware; *)
438	Functional incompatibility (one or more PC boards in the inverter are not compatible with each other, e.g. after a PC board has been replaced)		
445	- Compatibility error (e.g. due to replacement of a PC board) - Invalid power stage set configuration	The inverter is not feeding any energy into the grid.	Update inverter firmware; *)
447	Insulation fault (PV or battery)	The inverter is not feeding any energy into the grid.	*)
450	Guard cannot be found		

Code	Description	Behaviour	Remedy
451	Memory error detected		
452	Communication error between the processors		
453	Grid voltage and power stage set are incompatible	The inverter will automatically attempt to connect again and, if possible, will resume feeding energy into the grid.	*)
454	Grid frequency and power stage set are incompatible		
456	Anti-islanding function is no longer being implemented correctly		
457	Grid relay is sticking or the neutral conductor ground voltage is too high		
458	Error when recording measuring signal		
459	Error when recording the measuring signal for the insulation test		
460	Reference voltage source for the digital signal processor (DSP) is working out of tolerance	The inverter is not feeding any energy into the grid.	*)
461	DSP data memory error		
462	Error during DC feed monitoring routine		
463	Reversed AC polarity, AC connector inserted incorrectly		
474	RCMU sensor faulty		
475	Insulation fault (connection between solar module and ground)	The inverter is not feeding any energy into the grid.	**)
476	Driver supply voltage too low		
480, 481	Functional incompatibility (one or more PC boards in the inverter are not compatible with each other, e.g. after a PC board has been replaced)	The inverter is not feeding any energy into the grid.	Update inverter firmware; *)
482	Setup interrupted after initial start-up		
484 - 489	CAN transmit buffer is full	The inverter is not feeding any energy into the grid.	Perform AC reset (switch automatic circuit breaker off and on again); update inverter firmware; *)

*) If the status code is displayed all the time: Notify a Fronius-trained service engineer.

***) If this status code keeps recurring, contact your system engineer.

Status codes – Class 5

Class 5 status codes do not generally interfere with feeding energy into the grid, but can cause restrictions. These status codes are displayed until they are acknowledged by pressing a key (however, the inverter continues to operate normally in the background).

Code	Description	Behaviour	Remedy
502	Insulation fault on solar modules or on Fronius Solar Battery	Warning message is shown on the display	**)
509	No energy fed into the grid in the past 24 hours	Warning message is shown on the display	Acknowledge status code; check whether all the conditions for the problem-free feeding of energy into the grid have been met (e.g. are the solar modules covered with snow?); **)
515	Unable to communicate with filter	Warning message on the display	*)
516	Unable to communicate with the data storage unit	Data storage unit warning message	*)
517	Power derating caused by excessively high temperatures	When power derating occurs, a warning message is shown on the display.	If necessary, purge cooling air openings and heat sink; fault is rectified automatically; **)
519	Unable to communicate with the data storage unit	Data storage unit warning message	*)
520	No energy fed into the grid by the PV in the past 24 hours	Warning message is shown on the display	Acknowledge status code; check whether all the conditions for the problem-free feeding of energy into the grid have been met (e.g. are the solar modules covered with snow?); *)
522	DC low (PV). No PV voltage available.	Warning message on the display	In the case of hybrid systems, this message appears overnight if no photovoltaics are connected to the Fronius Symo Hybrid or in standby mode; *)
523	DC low (battery). The battery has been activated but is either not connected or is not switched on.	Warning message on the display	Switch on, connect or check battery; *)
558, 559	Functional incompatibility (one or more PC boards in the inverter are not compatible with each other, e.g. after a PC board has been replaced)	Warning message on the display	Update inverter firmware; *)
560	Power derating caused by overfrequency	Displayed when grid frequency becomes excessively high. The power is reduced.	As soon as the grid frequency is back within the permissible range and the inverter has returned to normal operation, the fault is rectified automatically; **)
567	Power derating caused by overvoltage	Displayed when grid voltage becomes excessively high. The power is reduced.	As soon as the grid voltage is back within the permissible range and the inverter has returned to normal operation, the fault is rectified automatically; **)
573	Power derating caused by excessively low temperatures	When power derating occurs, a warning message is shown on the display.	Fault rectified automatically; **)

*) If the status code is displayed all the time: Notify a Fronius-trained service technician.

**) If this status code keeps recurring, contact your system engineer.

Status codes – Class 6 Some of the class 6 status codes necessitate intervention by a Fronius-trained service engineer.

Code	Description	Behaviour	Remedy
601	CAN bus is full	The inverter is not feeding any energy into the grid.	Update inverter firmware; *)
603	DC module temperature sensor faulty	The inverter will automatically attempt to connect again and, if possible, will resume feeding energy into the grid.	*)
608	Functional incompatibility (one or more PC boards in the inverter are not compatible with each other, e.g. after a PC board has been replaced)	The inverter is not feeding any energy into the grid.	Update inverter firmware; *)

*) If the status code is displayed all the time: Notify a Fronius-trained service engineer.

***) Fault is rectified automatically. If this status code keeps recurring, contact your system engineer.

Status codes – Class 7 Class 7 status codes relate to the control system, the configuration and inverter data recording, and may directly or indirectly affect the process of feeding energy into the grid.

Code	Description	Behaviour	Remedy
701 - 715	Provides information about the internal processor status	Warning message on the display	*)
721	EEPROM has been re-initialised	Warning message on the display	Acknowledge status code; *)
722 - 730	Provides information about the internal processor status	Warning message on the display	*)
746	Error occurred during update process	Warning message on the display, update process is interrupted	Wait for 2 minutes, then start the update again; *)
751	Time lost	Warning message on the display	Reset time and date on the inverter; *)
752	Real Time Clock module communication error		
753	Internal error: Real Time Clock module is in emergency mode	Time may be inaccurate or lost (feeding energy into the grid normal)	Reset time and date on the inverter
754 - 755	Provides information about the internal processor status	Warning message on the display	*)
757	Hardware error in the Real Time Clock module	Error message on the display; the inverter is not feeding any energy into the grid	*)
758	Internal error: Real Time Clock module is in emergency mode	Time may be inaccurate or lost (feeding energy into the grid normal)	Reset time and date on the inverter
760	Internal hardware error	Error message on the display	*)

Code	Description	Behaviour	Remedy
761 - 765	Provides information about the internal processor status	Warning message on the display	
766	Emergency power limitation has been activated (max. 750 W)	Error message on the display	*)
767	Provides information about the internal processor status		
768	Different power limitation in the hardware modules	Warning message on the display	*)
772	Data storage unit not available		
773	Software update group 0 (invalid country setup)		
775	PMC power stage set not available	Warning message on the display	Press "Enter" key to acknowledge error; *)
776	Invalid device type		
781 - 794	Provides information about the internal processor status	Warning message on the display	*)

*) If the status code is displayed all the time: Notify a Fronius-trained service engineer.

Status codes – Class 9

Class 9 status codes are only displayed on the system monitoring page and are not shown on the inverter display.

Code	Description	Behaviour	Remedy
975	Software on device is inconsistent	The inverter is not feeding any energy into the grid.	Update inverter firmware; *)
976	Unregistered battery module detected	Battery operation not possible, feed-in resumes	
977	Incorrect number of battery modules connected to Fronius Solar Battery	Too many modules detected: Battery operation not possible Too few modules detected: Error message output, operation resumes	Enter activation key for battery module; *)
978	Communication error between Fronius Symo Hybrid and Fronius Solar Battery	Battery operation not possible, feed-in resumes	Check wiring; **)
979	Communication error between Fronius Symo Hybrid and Fronius Solar Battery	Battery operation not possible, feed-in resumes	Displayed in standby mode, if not in standby mode - check wiring; **)
980	No communication between Fronius Symo Hybrid and Fronius Solar Battery	Battery operation not possible, feed-in resumes	Switch on Fronius Solar Battery; check wiring; **)
981	Software version of Fronius Solar Battery is inconsistent	Battery operation not possible, feed-in resumes	*)
983	Communication error between battery controller and battery modules	Battery operation not possible, feed-in resumes	Check wiring in Fronius Solar Battery; check numbers of individual battery modules; check termination plug
984	Battery controller has stopped Charge mode	Battery operation not possible, feed-in resumes	Check error message on Fronius Solar Battery display; *)

Code	Description	Behaviour	Remedy
985	Undervoltage at Fronius Solar Battery	Fronius Solar Battery has tripped due to undervoltage. Battery operation not possible, feed-in resumes	*)
986	Overtemperature at Fronius Solar Battery	Fronius Solar Battery has tripped due to overtemperature. Battery operation not possible, feed-in resumes	Reduce ambient temperature; switch off Fronius Solar Battery and activate it again after waiting an appropriate amount of time; *)
987	Undertemperature at Fronius Solar Battery	Fronius Solar Battery has tripped due to undertemperature. Battery operation not possible, feed-in resumes	Increase ambient temperature; switch off Fronius Solar Battery and activate it again after waiting an appropriate amount of time; *)
988	Communication error between Fronius Symo Hybrid and Fronius Smart Meter	No meter data available Battery operation not possible, feed-in resumes	Check wiring; **)
989	No communication between Fronius Symo Hybrid and Fronius Smart Meter	No meter data available Battery operation not possible, feed-in resumes	Check wiring; check Fronius Smart Meter power supply; **)

*) If the status code is displayed all the time: Notify a Fronius-trained service technician.

**) If this status code keeps recurring, contact your system engineer.

Class 10 - 12 status codes

1000 - 1299- Provide information on the status of the internal processor program

Description Is of no concern when the inverter is working properly and only appears in the "Status PS" setup parameter. In the event of an actual error, this status code assists Fronius Technical Support during the error analysis.

Customer service

IMPORTANT! Contact your Fronius dealer or a Fronius-trained service technician if

- an error appears frequently or all the time
- an error appears that is not listed in the tables

Operation in dusty environments

When operating the inverter in extremely dusty environments: when necessary, clean the cooling elements and fan on the back of the inverter as well as the air intakes at the mounting bracket using clean compressed air.

Fronius Solar Battery

Status code display

The storage system performs a system self-diagnosis that automatically detects many faults that may occur. These are indicated on the display or via LEDs. This means you are promptly made aware of malfunctions in the storage system, or of any installation or operating faults.

If the system self-diagnosis has detected a specific fault, the associated status code will be shown on the display.

Error messages – Battery management module

Indicator	Details	Solution
NO MODULE	No module	Connect modules
	If modules are connected	The message on the left appears even if modules are connected. Check whether they have been connected properly.
OV Error	Overvoltage	Discharge
DISCHARGE ERR	Deep discharge	Charge
COMM ERR or CON= ----- -ooox	Error affecting communication with connected modules. The example on the left illustrates a scenario in which one module (no. 00) is affected by a communication error, 3 modules (nos. 01, 02 and 03) are connected and the other addresses are without a connection.	
COMM OFF MODE	For maintenance only	
No information displayed	Wiring error, storage module addressing error or system-critical error	Check wiring, check address settings for individual storage modules

Error message – Data converter

If the data converter detects an error, the “State” LED lights up steady red to signal that an error has occurred. At the same time, the associated error messages are displayed via the “Error No” LEDs in accordance with table below. There are two different error categories: Serious errors (1 - 5): In this case, the data converter has to be switched off and then back on again. If the error recurs, the data converter must be replaced and sent away for repair. Warnings (6 - 15): These warnings are displayed for information only. They appear for 1 minute and are then reset automatically. If these warnings occur quite frequently, Customer Services should be notified accordingly.

These displays are not applicable in Configuration mode and are intended for internal purposes only.

LED8	LED4	LED2	LED1	Error no. or ID	Display
0	0	0	0	0	Reserved
0	0	0	1	1	Hardware fault
0	0	1	0	2	EEROM fault

0	0	1	1	3	Internal memory error
0	1	0	0	4	Fieldbus hardware fault
0	1	0	1	5	Script error
0	1	1	0	6	Reserved
0	1	1	1	7	RS transmission buffer overflow
1	0	0	0	8	RS receiver buffer overflow
1	0	0	1	9	RS timeout
1	0	1	0	10	General fieldbus error
1	0	1	1	11	Parity error or stop bit error (frame check)
1	1	0	0	12	Reserved
1	1	0	1	13	Fieldbus configuration error
1	1	1	0	14	Fieldbus data buffer overflow
1	1	1	1	15	Reserved

Undefined operating statuses

Battery switches off during start-up procedure:

Keep the battery switched off for at least 120 minutes and then switch it on again. If this does not resolve the error, notify Customer Services.

Battery switched off with a SOC (state of charge) of 0%:

Communication error – Disconnect the inverter on the DC side and isolate it from the grid on the AC side. Wait 5 minutes and then reconnect the inverter on both the DC and AC sides. If this does not resolve the error, notify Customer Services.

Battery active, state of charge (SOC) is more than 90% and red LED is flashing:

Battery charging error – Disconnect the inverter on the DC side and isolate it from the grid on the AC side. Wait 30 minutes and then reconnect the inverter on both the DC and AC sides. If this does not resolve the error, notify Customer Services.

Battery not charging or discharging (SOC indicated on web interface does not match that of the battery):

Check whether battery is switched on – If it is not, switch it on.

If it is, there is a communication error – Disconnect the inverter on the DC side and isolate it from the grid on the AC side. Wait 5 minutes and then reconnect the inverter on both the DC and AC sides. If this does not resolve the error, notify Customer Services.

Battery no longer being displayed on web interface (triangular view instead of square view):

Check whether battery is switched on – If it is not, switch it on.

If it is, there is a communication error – Disconnect the inverter on the DC side and isolate it from the grid on the AC side. Wait 5 minutes and then reconnect the inverter on both the DC and AC sides. If this does not resolve the error, notify Customer Services.

Whenever an error message of any kind appears on the battery display:

Disconnect the inverter on the DC side and isolate it from the grid on the AC side. Wait 5 minutes and then reconnect the inverter on both the DC and AC sides. If this does not resolve the error, notify Customer Services.

Unusual increase in temperature or strange smells:

Switch off the system (battery main switch, DC side of inverter), ventilate the room and inform Customer Services.

Appendix

Technical data

Fronius Symo Hybrid	3.0-3-S	4.0-3-S	5.0-3-S
Input data			
PV input power	5 kW	6.5 kW	8 kW
MPP voltage range	190 - 800 V DC	250 - 800 V DC	315 - 800 V DC
Max. input voltage (at 1,000 W/m ² / -10 °C in an open circuit)	1000 V DC		
Feed-in start voltage	200 V		
Nominal input voltage	595 V		
Min. input voltage	150 V DC		
Max. input current	1 x 16.0 A		
Max. short circuit current of the solar modules (I _{SC PV})	24.0 A		
Number of MPP trackers	1		
Number of DC connections	2		
Battery input			
Max. output power to battery	Dependent on connected Fronius Solar Battery		
Max. input power from battery	Dependent on connected Fronius Solar Battery		
Output data			
Nominal output power (P _{nom})	3000 W	4000 W	5000 W
Max. output power	3000 VA	4000 VA	5000 VA
Nominal grid voltage	3~ NPE 400/230 V 3~ NPE 380/220 V (+20% / -30%)		
Max. output current	8.3 A	8.3 A	8.3 A
Frequency (frequency range)	50 Hz / 60 Hz (45 - 65 Hz)		
Total harmonic distortion	< 3%		
cos phi power factor	0.85 - 1 ind./cap. ²⁾		
Power-up current pulse ⁶⁾ and duration	38 A / 2 ms		
Max. overcurrent protection	25 A		
General data			
Max. efficiency (PV - grid)	97.5%	97.6	
Max. efficiency (PV - battery - grid)	> 90%	> 90%	> 90%
European efficiency (PV - grid)	95.2%	95.7%	96%
Cooling	Controlled forced-air ventilation		
Degree of protection	IP 65		
Dimensions h x w x d	645 x 431 x 204 mm		
Weight	22 kg		
Permissible ambient temperature	- 25 °C - +60 °C		
Permitted humidity	0 - 100%		
EMC device class	B		
Overvoltage category DC / AC	3 / 2		
Pollution level	2		
Noise emission	59.5 dB(A) ref. 1pW		
Protection devices			
DC insulation measurement	Integrated		
Response to DC overload	Operating point shift, power limitation		

Fronius Symo Hybrid	3.0-3-S	4.0-3-S	5.0-3-S
DC disconnector	Integrated		
RCMU	Integrated		

Fronius Solar Battery	Battery 4.5	Battery 6.0	Battery 7.5
Electrical parameters			
Usable capacity	3.6 kWh	4.8 kWh	6 kWh
Cycle stability	8000		
Voltage range	120 - 170 V	160 - 230 V	200 - 290 V
Nominal charging power	2400 W	3200 W	4000 W
Nominal discharge power	2400 W	3200 W	4000 W
Max. charging current (limited by inverter)	16.0 A		
Max. discharge current (limited by inverter)	16.0 A		
Recommended fuse rating	Fuse 20 A / 1 kV / fast		

General data			
Battery technology	LiFePO4		
Dimensions h x w x d	955 x 570 x 611 mm		
Weight	91 kg	108 kg	125 kg
Degree of protection	IP 20		
Protection class	1		
Permissible ambient temperature	5 °C - 35 °C		
Permissible storage temperature	-40 °C - 65 °C		
Permitted humidity	0% - 95% (non-condensing)		

Interfaces			
Connection to inverter	Modbus RTU (RS485)		

Fronius Solar Battery	Battery 9.0	Battery 10.5	Battery 12.0
Electrical parameters			
Usable capacity	7.2 kWh	8.4 kWh	9.6 kWh
Cycle stability	8000		
Voltage range	240 - 345 V	280 - 400 V	320 - 460 V
Nominal charging power	4800 W	5600 W	6400 W
Nominal discharge power	4800 W	5600 W	6400 W
Max. charging current (limited by inverter)	16.0 A		
Max. discharge current (limited by inverter)	16.0 A		
Recommended fuse rating	Fuse 20 A / 1 kV / fast		

General data			
Battery technology	LiFePO4		
Dimensions h x w x d	955 x 570 x 611 mm		
Weight	142 kg	159 kg	176 kg
Degree of protection	IP 20		
Protection class	1		
Permissible ambient temperature	5 °C - 35 °C		
Permissible storage temperature	-40 °C - 65 °C		
Permitted humidity	0 - 95%		

Fronius Solar Battery	Battery 9.0	Battery 10.5	Battery 12.0
Interfaces			
Connection to inverter		Modbus RTU (RS485)	

System monitoring	Supply voltage	12 V DC
	Energy consumption	< 2 W
	Dimensions	132 x 103 x 22 mm 5.2 x 4.1 x 0.9 in.
	Ethernet (LAN)	RJ45, 100 Mbit
	WLAN	IEEE 802.11b/g/n client
	Ambient temperature	-20 - +65 °C -4 - +149 °F
	I/O connection specifications	
	Voltage level of digital inputs	Low = min. 0 V - max. 1.8 V High = min. 3 V - max. 24 V (+20%)
	Input current values of digital inputs	Dependent on input voltage; input resistance = 46 kohms
	Switching capacity of digital outputs when supplied by Datamanager plug-in card	3.2 W
	12.8 V in total for all 4 digital outputs	
Max. switchable inductive loads at digital outputs	76 mJ (per output)	
Modbus RTU	RS485 2-wire	
Factory settings for RS485 interface:		
Speed	9600 baud	
Data frames	1 start bit 8 Data bits No parity 1 stop bit	

- Explanation of footnotes**
- 1) The values stated are defaults; the inverter is configured specifically to suit the requirements of the relevant country.
 - 2) Depending on the country setup or device-specific settings (ind. = inductive; cap. = capacitive)
 - 3) PCC = interface to the public grid
 - 4) Maximum current from the inverter to the solar module when an error occurs in the inverter
 - 5) Guaranteed by the electrical configuration of the inverter
 - 6) Current peak when switching on the inverter

Applicable standards and guidelines

Fronius hybrid inverter:

CE mark

The devices conform to all the requisite and relevant standards and guidelines that form part of the relevant EU directive, and are therefore permitted to display the CE mark.

Emergency power operation

This version of the hybrid inverter is only intended for use in grid connected photovoltaic systems. A device update is required from the manufacturer in order to generate power independently of the public grid. As well as providing functional enhancements for the hardware and software, this update also includes relevant user documentation.

The hybrid inverter is delivered ready for supplying emergency power.

Power outage

The standard measurement and safety procedures integrated into the inverter ensure that in the event of a power outage, the feed-in of energy is immediately interrupted (e.g. switch-off by the energy supplier or damage to lines).

Fronius Solar Battery:

- IEC/EN 62133
- EN 50178 (1997)
- EN 61000-6-2:2005
- EN 61000-6-3:2007 + A1:2011
- EN 62208
- EN 62311:2008
- FCC Part 15 Subpart B:2012 Class B
- IEC 60730-1 (Fourth Edition) 2010 (H.7, H.11.12, H.27.1.2)
- UN 38.3
- 60730-1 2011 (H.7, H.11.12, H.27.1.2)

Warranty terms and conditions, and disposal

Fronius manufacturer's warranty

Detailed, country-specific warranty terms are available on the internet:
www.fronius.com/solar/warranty

To obtain the full warranty period for your newly installed Fronius inverter or storage system, please register at: www.solarweb.com.

Disposal

If you need to replace your inverter or your battery at some point, Fronius will take back the old device and arrange for it to be recycled in an appropriate manner.

Fronius Worldwide - www.fronius.com/addresses

Fronius International GmbH
4600 Wels, Froniusplatz 1, Austria
E-Mail: pv-sales@fronius.com
<http://www.fronius.com>

Fronius USA LLC Solar Electronics Division
6797 Fronius Drive, Portage, IN 46368
E-Mail: pv-us@fronius.com
<http://www.fronius-usa.com>

Under <http://www.fronius.com/addresses> you will find all addresses of our sales branches and partner firms!